



Disclaimer

This user manual is provided as a free service by FixYourDLP.com. FixYourDLP is in no way responsible for the content of this manual, nor do we guarantee its accuracy. FixYourDLP does not make any claim of copyright and all copyrights remain the property of their respective owners.

About FixYourDLP.com

FixYourDLP.com (<http://www.fixyourdpl.com>) is the World's #1 resource for media product news, reviews, do-it-yourself guides, and manuals.

Informational Blog: <http://www.fixyourdpl.com>

Video Guides: <http://www.fixyourdpl.com/guides>

User Forums: <http://www.fixyourdpl.com/forum>

FixYourDLP's Fight Against Counterfeit Lamps:

<http://www.fixyourdpl.com/counterfeits>

Sponsors:

RecycleYourLamp.org – Free lamp recycling services for used lamps:

<http://www.recycleyourlamp.org>

Lamp Research - The trusted 3rd party lamp research company:

<http://www.lampresearch.com>

Discount-Merchant.com – The worlds largest lamp distributor:

<http://www.discount-merchant.com>



FixYourDLP.com

Sponsored by 

**EX30/EX50/EX70
Multimedia Projector**

User's Guide



Discount-Merchant.com (800) 281-8860
THE TRUSTED SOURCE FOR PROJECTOR LAMPS AND ACCESSORIES

Important Safety Information

WARNING: Never look into the projector lens when the lamp is turned on; the bright light can damage your eyes. Never let children look into the lens when it is on. Never open any cover on the projector, except the lamp and filter covers. Dangerous electrical voltages inside the projector can severely injure you. Except as specifically explained in this *User's Guide*, do not attempt to service this product yourself. Refer all servicing to qualified service personnel.

WARNING: The projector and its accessories come packaged in plastic bags. Keep plastic bags away from small children to avoid any risk of suffocation.

Caution: When you replace the lamp, never touch the new lamp with your bare hands; the invisible residue left by the oil on your hands may shorten the lamp life. Use a cloth or glove to handle the new lamp.

Copyright Notice

All rights reserved. No part of this publication may be reproduced, stored in a retrieval system, or transmitted in any form or by any means, electronic, mechanical, photocopying, recording, or otherwise, without the prior written permission of Seiko Epson Corporation. The information contained herein is designed only for use with this Epson product. Epson is not responsible for any use of this information as applied to other products.

Neither Seiko Epson Corporation nor its affiliates shall be liable to the purchaser of this product or third parties for damages, losses, costs, or expenses incurred by purchaser or third parties as a result of: accident, misuse, or abuse of this product or unauthorized modifications, repairs, or alterations to this product, or (excluding the U.S.) failure to strictly comply with Seiko Epson Corporation's operating and maintenance instructions.

Seiko Epson Corporation shall not be liable for any damages or problems arising from the use of any options or any consumable products other than those designated as Original Epson Products or Epson Approved Products by Seiko Epson Corporation.

Software Copyright:

This product uses free software as well as software to which this company holds the rights.

The following is information on the free software used by this product.

Hereafter, each author, the conditions, and so on are described in the original. Furthermore, there is no guarantee for free software because of the characteristics of the free software that has already been used in this product; any problems in this product (including problems that originate with the free software concerned) do not influence the conditions of the guarantee (written guarantee) issued by this company.

(1) libjpeg

© 1991-1998 Thomas G. Lane.

This software is based in part on the work of the Independent JPEG Group.

(2) libpng

© 1998-2004 Glenn Randers-Pehrson

© 1996-1997 Andreas Dilger

© 1995-1996 Guy Eric Schalnat, Group 42, Inc.

(3) zlib

© 1995-2003 Jean-loup Gailly and Mark Adler



Discount-Merchant.com (800) 281-8860

THE TRUSTED SOURCE FOR PROJECTOR LAMPS AND ACCESSORIES

Trademarks

Epson and Instant Off are registered trademarks, and Epson Exceed Your Vision is a registered logomark of Seiko Epson Corporation.

PrivateLine is a registered trademark, SizeWise is a trademark, and Extra Care is a service mark of Epson America, Inc.

Pixelworks, DNX, and the DNX logo are trademarks of Pixelworks, Inc.

HDMI, the HDMI logo, and High-Definition Multimedia Interface are trademarks or registered trademarks of HDMI Licensing, LLC.

General Notice: Other product names used herein are for identification purposes only and may be trademarks of their respective owners. Epson disclaims any and all rights in those marks.

This information is subject to change without notice.

© 2008 Epson America, Inc.

6/08



Discount-Merchant.com (800) 281-8860
THE TRUSTED SOURCE FOR PROJECTOR LAMPS AND ACCESSORIES



Discount-Merchant.com (800) 281-8860

THE TRUSTED SOURCE FOR PROJECTOR LAMPS AND ACCESSORIES

C

Contents

<i>Welcome</i>	9
Using Your Documentation	10
Getting More Information	11
Registration and Warranty	12
Optional Accessories	12

1 <i>Setting Up the Projector</i>	15
Unpacking the Projector	16
Additional Components	17
Positioning the Projector	17
Projector Placement Options	23
Connecting to a Computer	24
Connecting to the USB Port	24
Connecting to the VGA Computer Port	26
Connecting to Video Equipment	27
Connecting an HDMI Video Source (EX70 only)	28
Connecting a Composite Video Source	29
Connecting an S-Video Source	30
Connecting a Component Video Source	31
Connecting an RGB Video Source	32
Connecting an External Monitor (EX30 or EX50 only)	33
Playing Sound Through the Projector	34
Connecting a Digital Camera or Other USB Device (EX70 Only)	34
Inserting an SD Card (EX70 Only)	36



Turning the Projector On and Off	37
Using the Direct Power On Function	39
Shutting Down the Projector	40

2 <i>Displaying and Adjusting the Image</i>	41
Selecting an Image Source	42
Adjusting the Image	43
Adjusting the Position of the Image	43
Adjusting the Image Shape	44
Focusing and Zooming the Image	45
Selecting the Color Mode	46
Resizing Video Images	47

3 <i>Presenting With the Remote Control</i>	49
Using the Remote Control	50
Controlling the Picture and Sound	50
Turning Off the Picture and Sound	50
Stopping Action	51
Zooming In on Your Image	51
Controlling the Volume	52
Operating Your Computer With the Remote Control	53
Presenting a Slideshow (EX70 Only)	55
Starting a Slideshow	55
Selecting Slideshow Display Options	57

4 <i>Fine-Tuning the Projector</i>	59
Using the Menu System	60
Restoring the Default Settings	61
Adjusting the Image	61
Adjusting Signal Settings	63
Customizing Projector Features	65
Customizing Power and Operation	66
Using the Projector Security Features	67
Enabling Password Protection	68
Creating Your Own Startup Screen	70
Disabling the Projector's Buttons	72
Using Security Locking	72



5	<i>Maintaining the Projector</i>	75
	Cleaning the Lens.....	76
	Cleaning the Projector Case.....	76
	Cleaning the Air Filter.....	76
	Replacing the Air Filter.....	77
	Replacing the Lamp.....	78
	Resetting the Lamp Timer.....	80
	Checking Lamp Usage.....	81
	Replacing the Remote Control Batteries.....	82
	Transporting the Projector.....	83
6	<i>Solving Problems</i>	85
	Using On-Screen Help.....	86
	Checking Projector Status.....	87
	What To Do When the Lights Flash.....	87
	Solving Projector Operation Problems.....	89
	Solving Problems With the Image or Sound.....	89
	Solving Problems With the Remote Control.....	95
	Where To Get Help.....	96
	Speak to a Support Representative.....	96
A	<i>Technical Specifications</i>	99
B	<i>Notices</i>	109
	Important Safety Instructions.....	109
	FCC Compliance Statement.....	112
	<i>Index</i>	113



Discount-Merchant.com (800) 281-8860
THE TRUSTED SOURCE FOR PROJECTOR LAMPS AND ACCESSORIES



Discount-Merchant.com (800) 281-8860
THE TRUSTED SOURCE FOR PROJECTOR LAMPS AND ACCESSORIES

W

Welcome

The EX30/EX50/EX70 is an easy-to-use, compact, lightweight projector with a built-in speaker. It offers up to 2200 lumens (EX30/EX50) or 2000 lumens (EX70) of white and color light output (brightness). It also provides a native SVGA (EX30), XGA (EX50), or WXGA (EX70) resolution. You can connect it to a wide range of computers and video sources. You can also project from a USB or SD™ storage device (EX70 only).

Your projector offers these easy setup, control, and security features:

- **Plug n' Project setup**—No hassle, one-step connect and project with USB
- **Ultra HD-quality with just one cable**—HDMI audio/video connection (EX70 only)
- **PC-free slideshows and presentations**—SD card slot and USB thumb drive port (EX70 only)
- **Quick, convenient control**—Direct Power Off, sleep mode, Instant Off®/On
- **Easy picture adjustment**—ultra flexible, Auto Keystone correction and digital zoom (EX50/EX70 only)
- **One-touch filter replacement**
- **Top-loading easy lamp access**
- **Security features**—password protection, user's logo, projector button lock, security cable attachment (cable not included), and a slot for an optional Kensington® security lock



Discount-Merchant.com (800) 281-8860
THE TRUSTED SOURCE FOR PROJECTOR LAMPS AND ACCESSORIES

Additional enhancements:

- 2000:1 contrast ratio (with Auto Iris setting turned on) and vibrant color display
- Integral lens cover (A/V Mute slide) that won't get lost
- Low power, long-lasting lamp with High and Low Brightness modes
- Ability to project PowerPoint® slide images without a computer while viewing handout notes and controls on the computer screen (EX70 only).
- Carrying case included

Using Your Documentation

This book contains all the information you need to set up and use your projector. Please follow these guidelines as you read through it:

- Warnings must be followed carefully to avoid bodily injury.
- Cautions must be observed to avoid damage to your equipment.
- Notes contain important information about your projector.
- Tips contain additional projection hints.

Getting More Information

Need tips on giving presentations? Quick steps for setting up your projector? Here's where you can look for help:

- **Quick Setup sheet**
Provides information for connecting the projector to your equipment, displaying and adjusting the image, and solving display problems.
- **Built-in help system**
Provides assistance for common problems. Available from the ? Help button on the projector or the remote control. See page 86 for details.
- **epson.com/support**
Download FAQs and e-mail your questions to Epson support.
- **PrivateLine® support**
If you still need help after checking this *User's Guide* and the sources listed in this section, you can use the Epson PrivateLine Support service to get help fast. Call (800) 637-7661 and enter the PIN on the PrivateLine card. Or take advantage of Epson's automated support services 24 hours a day. See page 96 for more information.
- **presentersonline.com**
Includes a library of articles covering presentation tips, tricks, and technology. The site provides templates, clip art, and sound clips, as well as Presenters Services to use on the road. Even more resources and services are available if you register to join the Presenters Club—and it's free.



Discount-Merchant.com (800) 281-8860
THE TRUSTED SOURCE FOR PROJECTOR LAMPS AND ACCESSORIES

Welcome 11

Registration and Warranty

Your projector comes with a basic warranty that lets you project with confidence. For details, see the warranty brochure included with your projector.

In addition, Epson offers free Extra CareSM Road Service. In the unlikely event of an equipment failure, you won't have to wait for your unit to be repaired. Instead, Epson will ship you a replacement unit anywhere in the United States or Canada, usually via overnight delivery. See the brochure included with your projector for details.

To register, simply fill out the registration card and mail it to Epson. Or you can register online at epson.com/webreg. Registering also lets you receive special updates on new accessories, products, and service.

Optional Accessories

To enhance your use of the projector, Epson offers the following optional accessories:

Product	Part number
Replacement lamp	V13H010L41
Replacement air filter	V13H134A13
Universal projector ceiling mount	ELPMBPJF
Advanced projector ceiling mount with precision gear	ELPMBPRG
High security projector ceiling mount	ELPMBATA
Adjustable suspended ceiling channel kit	ELPMBP01
False ceiling plate kit	ELPMBP02
Structural round ceiling plate	ELPMBP03
Adjustable extension column (pipe) 8" - 11"	ELPMBC01
Kensington security lock	ELPSL01
50-inch portable screen (4:3 aspect ratio)	ELPSC06
60-inch portable pop-up screen (4:3 aspect ratio)	ELPSC07
80-inch portable pop-up screen (4:3 aspect ratio)	ELPSC08
Accolade™ DUET™ Portable Projector Screen (4:3/16:9)	ELPSC80
Component-to-VGA video cable	ELPKC19
S-Video cable	ELPSV01

Product	Part number
Distribution amplifier	ELPDA01
Image presentation camera (ELPDC05) DC-10s document camera	V12H162020 ELPDC10S
Soft carrying case (projector only) Soft shoulder case for projector and notebook Wheeled soft carrying case Molded hard-shell wheeled carrying case Swiss Gear® backpack	V12H00160 ELPKS61 ELPKS62 ELPKS58 ELPKS63

You can purchase screens or other accessories from an Epson authorized reseller. To find the nearest reseller, call 800-GO-EPSON (800-463-7766). Or you can purchase online at www.epsonstore.com (U.S. sales) or www.epson.ca (Canadian sales).



Discount-Merchant.com (800) 281-8860
THE TRUSTED SOURCE FOR PROJECTOR LAMPS AND ACCESSORIES



Discount-Merchant.com (800) 281-8860

THE TRUSTED SOURCE FOR PROJECTOR LAMPS AND ACCESSORIES

14 *Welcome*

1 *Setting Up the Projector*

This chapter tells you how to unpack the projector and connect it to a notebook or desktop computer, and/or to video equipment, such as a VCR, DVD player, or video camera.

You can also connect the projector to a USB storage device or digital camera, or project from an inserted SD card (EX70 only).

Follow the instructions in this chapter on:

- Unpacking the projector
- Positioning the projector
- Connecting to a computer
- Connecting to video equipment
- Connecting an external monitor (EX30 and EX50 only)
- Playing sound through the projector
- Connecting to a digital camera or other USB device (EX70 only)
- Inserting an SD card (EX70 only)
- Turning the projector on and off

Unpacking the Projector

After unpacking the projector, make sure you have all these parts:

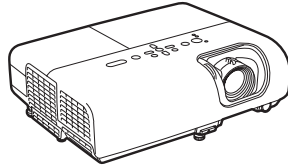

Projector

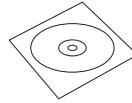

PDF manuals and registration CD-ROM



Password Protected sticker

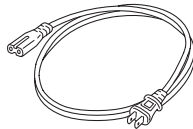

Power cord

Remote control



EX30/EX50



2 AA batteries (for remote control)

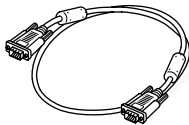

VGA computer cable



EX70

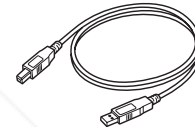

USB cable

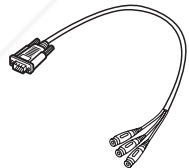

Component-to-VGA video adapter (EX30/EX50 only)

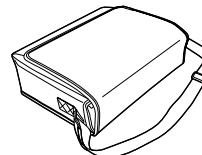

Carrying case

Save all packaging in case you need to ship the projector. Always use the original packaging (or the equivalent) when you need to send the projector to another location. See page 83 for transportation instructions. (If you are moving the projector by hand, use the carrying case.)

Additional Components

Depending on how you plan to use the projector, you may need additional components:

- To receive an HDMI signal from your video device, you'll need an HDMI cable (EX70 only). One may be provided with your video equipment.
- To receive a component video signal from a DVD player or other video device, you'll need a component-to-VGA video cable. One may be provided with your video equipment. (A component-to-VGA video adapter is provided with the EX30/EX50).
- To receive an S-Video signal, you'll need an S-Video cable. One may be included with your video equipment, or you can purchase one from Epson. See "Optional Accessories" on page 12.
- To receive an audio signal, you'll need an RCA-type audio cable with two male plugs, or a stereo mini-jack audio adapter cable.

Positioning the Projector

If the projector isn't already installed in the room you're using, you'll probably want to place it on a table in front of the screen. This lets you stand in the front of the room, face the audience, and remain close enough to the equipment to be able to control it.

Keep these considerations in mind as you position the projector:

- Place the projector on a sturdy, level surface.
- Make sure there is plenty of space for ventilation around and under the projector.
- Make sure the projector is within 5.9 feet (1.8 meters) of a grounded electrical outlet or extension cord.

Image size increases with distance, but can vary depending on the aspect ratio (image shape), how you zoom into the image, and whether you've adjusted other image settings. Use the illustrations and tables below to help you determine the projection distance.

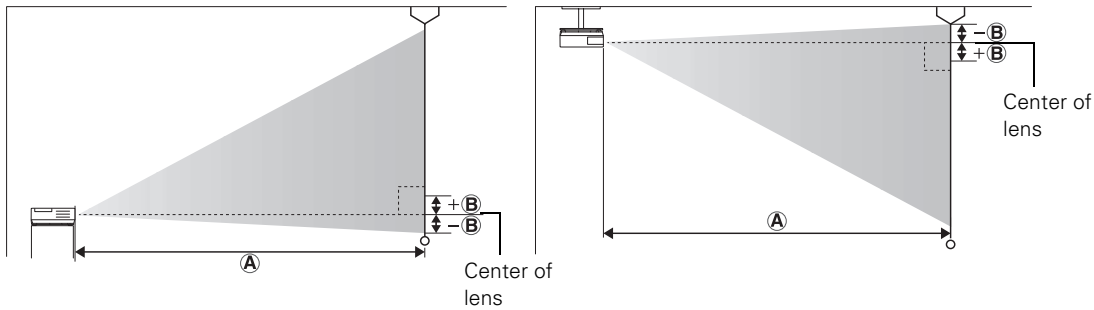

EX30 (4:3 images)

Screen size	Projection distance (A) Wide to Tele	Offset (B) Wide to Tele
30 inches (76 cm)	34 to 47 inches (87 to 119 cm)	-1.7 to +0.9 inches (-4 to +2 cm)
50 inches (127 cm)	58 to 79 inches (147 to 200 cm)	-2.8 to +1.4 inches (-7 to +4 cm)
60 inches (152 cm)	70 to 95 inches (177 to 240 cm)	-3.4 to +1.7 inches (-9 to +4 cm)
70 inches (178 cm)	82 to 110 inches (207 to 281 cm)	-4 to +2 inches (-10 to +5 cm)
80 inches (203 cm)	93 to 126 inches (237 to 321 cm)	-4.5 to +2.3 inches (-11 to +6 cm)
100 inches (254 cm)	117 to 158 inches (297 to 402 cm)	-5.7 to +2.9 inches (-14 to +7 cm)
150 inches (381 cm)	176 to 238 inches (447 to 605 cm)	-8.5 to +4.3 inches (-22 to +11 cm)
200 inches (508 cm)	235 to 318 inches (597 to 807 cm)	-11.3 to +5.7 inches (-29 to +15 cm)
300 inches (762 cm)	353 inches (897 cm)	-17 inches (-43 cm)
350 inches (889 cm)	412 inches (1047 cm)	-19.8 inches (-50 cm)

EX30 (16:9 images)

Screen size	Projection distance (A) Wide to Tele	Offset (B) Wide to Tele
30 inches (76 cm)	37 to 51 inches (95 to 130 cm)	+0.6 to +3.4 inches (+2 to +9 cm)
50 inches (127 cm)	63 to 86 inches (161 to 218 cm)	+1 to +5.6 inches (+3 to +14 cm)
60 inches (152 cm)	76 to 103 inches (193 to 262 cm)	+1.2 to +6.8 inches (+3 to +17 cm)
70 inches (178 cm)	89 to 120 inches (226 to 306 cm)	+1.4 to +7.9 inches (+4 to +20 cm)
80 inches (203 cm)	102 to 138 inches (259 to 350 cm)	+1.6 to +9 inches (+4 to +23 cm)
100 inches (254 cm)	128 to 173 inches (324 to 438 cm)	+2 to +11.3 inches (+5 to +29 cm)
150 inches (381 cm)	192 to 259 inches (487 to 659 cm)	+3 to +16.9 inches (+8 to +43 cm)
200 inches (508 cm)	256 to 346 inches (651 to 880 cm)	+4 to +22.6 inches (+10 to +57 cm)
300 inches (762 cm)	385 inches (978 cm)	+6 inches (+15 cm)
320 inches (813 cm)	411 inches (1043 cm)	+6.4 inches (+16 cm)

EX50 (4:3 images)

Screen size	Projection distance (A) Wide to Tele	Offset (B)
30 inches (76 cm)	33 to 40 inches (84 to 101 cm)	-1.9 inches (-5 cm)
40 inches (102 cm)	44 to 53 inches (113 to 136 cm)	-2.5 inches (-6 cm)
50 inches (127 cm)	56 to 67 inches (142 to 171 cm)	-3.1 inches (-8 cm)
60 inches (152 cm)	67 to 81 inches (171 to 206 cm)	-3.8 inches (-10 cm)
80 inches (203 cm)	90 to 108 inches (229 to 275 cm)	-5 inches (-13 cm)
100 inches (254 cm)	113 to 136 inches (287 to 345 cm)	-6.3 inches (-16 cm)

Screen size	Projection distance (A) Wide to Tele	Offset (B)
150 inches (381 cm)	170 to 204 inches (432 to 519 cm)	-9.4 inches (-24 cm)
200 inches (508 cm)	227 to 273 inches (577 to 693 cm)	-12.5 inches (-32 cm)
250 inches (635 cm)	284 to 341 inches (722 to 867 cm)	-15.6 inches (-40 cm)
300 inches (762 cm)	341 to 410 inches (867 to 1041 cm)	-18.8 inches (-48 cm)

EX50 (16:9 images)

Screen size	Projection distance (A) Wide to Tele	Offset (B)
28 inches (71 cm)	33 to 40 inches (85 to 103 cm)	+0.4 inch (+1 cm)
30 inches (76 cm)	36 to 43 inches (91 to 110 cm)	+0.4 inch (+1 cm)
40 inches (102 cm)	48 to 58 inches (123 to 148 cm)	+0.5 inch (+1 cm)
50 inches (127 cm)	61 to 73 inches (155 to 186 cm)	+0.7 inch (+2 cm)
60 inches (152 cm)	73 to 88 inches (186 to 224 cm)	+0.8 inch (+2 cm)
80 inches (203 cm)	98 to 118 inches (249 to 300 cm)	+1.1 inches (+3 cm)
100 inches (254 cm)	123 to 148 inches (313 to 376 cm)	+1.4 inches (+3 cm)
150 inches (381 cm)	185 to 223 inches (471 to 566 cm)	+2 inches (+5 cm)
200 inches (508 cm)	247 to 297 inches (629 to 755 cm)	+2.7 inches (+7 cm)
250 inches (635 cm)	310 to 372 inches (787 to 945 cm)	+3.4 inches (+9 cm)
275 inches (699 cm)	341 to 409 inches (866 to 1040 cm)	+3.7 inches (+10 cm)

EX70 (16:10 image)

Diagonal screen size	Projection distance (A) Wide to Tele
27 inches (69 cm)	33 to 40 inches (84 to 101 cm)
30 inches (76 cm)	37 to 45 inches (94 to 113 cm)
40 inches (102 cm)	50 to 60 inches (126 to 152 cm)
50 inches (127 cm)	62 to 75 inches (158 to 191 cm)
60 inches (152 cm)	75 to 90 inches (191 to 230 cm)
80 inches (203 cm)	101 to 121 inches (255 to 307 cm)
100 inches (254 cm)	126 to 152 inches (320 to 385 cm)
150 inches (381 cm)	190 to 228 inches (482 to 579 cm)
200 inches (508 cm)	253 to 305 inches (644 to 774 cm)
250 inches (635 cm)	317 to 381 inches (806 to 968 cm)

EX70 (4:3 image)

Screen size	Projection distance (A) Wide to Tele
24 inches (61 cm)	33 to 40 inches (84 to 102 cm)
30 inches (76 cm)	42 to 51 inches (106 to 129 cm)
40 inches (102 cm)	56 to 68 inches (143 to 173 cm)
50 inches (127 cm)	71 to 85 inches (180 to 217 cm)
60 inches (152 cm)	85 to 103 inches (216 to 260 cm)
70 inches (178 cm)	100 to 120 inches (253 to 304 cm)

Screen size	Projection distance (A) Wide to Tele
80 inches (203 cm)	114 to 137 inches (290 to 348 cm)
100 inches (254 cm)	143 to 172 inches (363 to 436 cm)
150 inches (381 cm)	215 to 258 inches (546 to 656 cm)
200 inches (508 cm)	287 to 345 inches (729 to 876 cm)
235 inches (597 cm)	338 to 406 inches (857 to 1030 cm)

EX70 (16:9 image)

Screen size	Projection distance (A) Wide to Tele	Offset (B)
27 inches (69 cm)	34 to 41 inches (86 to 104 cm)	+0.7 inch (+2 cm)
30 inches (76 cm)	38 to 46 inches (96 to 116 cm)	+0.8 inch (+2 cm)
40 inches (102 cm)	51 to 62 inches (130 to 156 cm)	+1.1 inches (+3 cm)
50 inches (127 cm)	64 to 77 inches (163 to 196 cm)	+1.4 inches (+3 cm)
60 inches (152 cm)	77 to 93 inches (196 to 236 cm)	+1.6 inches (+4 cm)
70 inches (178 cm)	90 to 109 inches (229 to 276 cm)	+1.9 inches (+5 cm)
80 inches (203 cm)	103 to 124 inches (263 to 316 cm)	+2.2 inches (+6 cm)
100 inches (254 cm)	130 to 156 inches (329 to 396 cm)	+2.7 inches (+7 cm)
150 inches (381 cm)	195 to 234 inches (495 to 596 cm)	+4.1 inches (+10 cm)
200 inches (508 cm)	261 to 313 inches (662 to 795 cm)	+5.5 inches (+14 cm)
260 inches (660 cm)	339 to 407 inches (861 to 1035 cm)	+7.1 inches (+18 cm)



Discount-Merchant.com (800) 281-8860

THE TRUSTED SOURCE FOR PROJECTOR LAMPS AND ACCESSORIES

Projector Placement Options

When projecting from the front, you should place the projector directly in front of the center of the screen, facing the screen squarely. The center of the lens should be about level with the bottom of the screen.

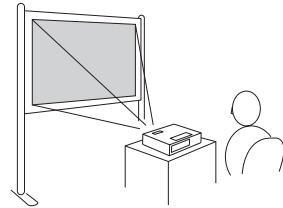

Front projection

note

After positioning the projector, you may want to connect a Kensington MicroSaver® anti-theft device to the lock port on the projector. You can purchase this from Epson; see page 12.

If you place the projector below screen level, you may need to tilt it up by extending the front adjustable foot. Tilting the projector causes the image to become “keystone” shaped, but you can correct the distortion (see page 44).

You can also install the projector in three other viewing setups: ceiling projection, rear projection onto a semi-transparent screen, or rear/ceiling projection.

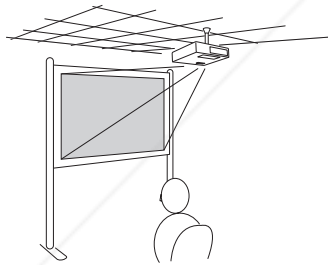

Ceiling projection

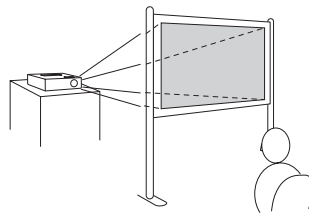

Rear projection

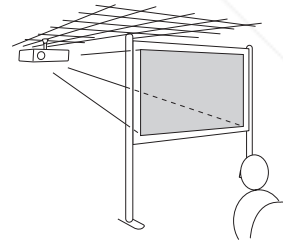

Rear/ceiling projection

To project from overhead, you'll need the optional ceiling mounting hardware (see page 12). You'll also need to select the appropriate Projection setting in the projector's Extended menu to orient the image correctly (see page 66).

Connecting to a Computer

You can connect the projector to a Windows® computer using the projector's TypeB USB port. This lets you carry a lightweight cable with you when you transport the projector.

You can also connect the projector to any computer that has a standard video output (monitor) port, including desktop models, PC notebook computers, Macintosh PowerBook® and iBook® computers, and hand-held devices. See page 26 for instructions.

To play sound through the projector, connect an audio cable (see page 34).

You may be able to use your remote control as a wireless mouse when projecting from a computer (see page 53).

Connecting to the USB Port

You can connect a Windows Vista, XP, or Windows 2000 (SP4) computer to the projector's TypeB (square)  USB port and project your computer's display. A USB 2.0 connection (recommended) provides better picture quality and response than USB 1.1.

The first time you connect a computer to the projector's USB port, software from the projector is installed on your computer.

1. Follow the instructions beginning on page 37 to turn on the projector.
2. Make sure the **USB Type B** setting on the Extended menu is set to **USB Display** (see page 66).
3. Turn on your computer.

4. Connect the square end of the USB cable that came with the projector to the projector's **TypeB** (square)  USB port.

EX30/EX50

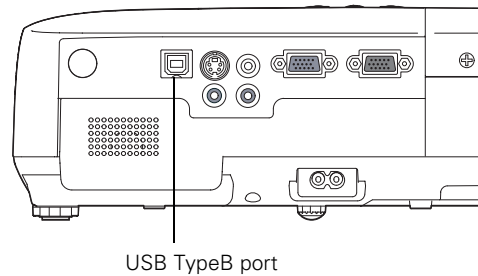

EX70

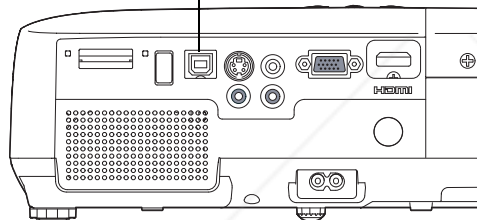

5. Connect the flat end of the cable to any available USB port on your notebook or desktop computer.

Messages appear on your computer screen as the projector is recognized and the software is installed automatically.

6. Follow the instructions on the screen to install the Epson USB Display software. If you see a “Digital Signature Warning,” select **Continue** or **Continue Anyway**. (You will see these instructions only the first time you connect.)

After the software is installed, you see your computer's current desktop displayed by the projector. You can switch the projector to other image sources using the **Source Search** or **Search** button on the remote control or the projector.

7. You can connect an optional audio cable if you want to play sound through the projector (see page 34).

When you've finished making connections, see Chapter 2 for instructions on displaying and adjusting the image.

When you're done projecting from your computer, disconnect the USB cable.

Connecting to the VGA Computer Port

You can connect to the projector using the VGA computer cable that came with it (the monitor port on your computer must be a D-sub 15-pin port).

1. Connect one end of the VGA computer cable to the projector's Computer (Component Video) port and the other end to your computer's monitor port.

caution

Don't try to force a connector to fit a port with a different shape or number of pins. You may damage the port or connector.

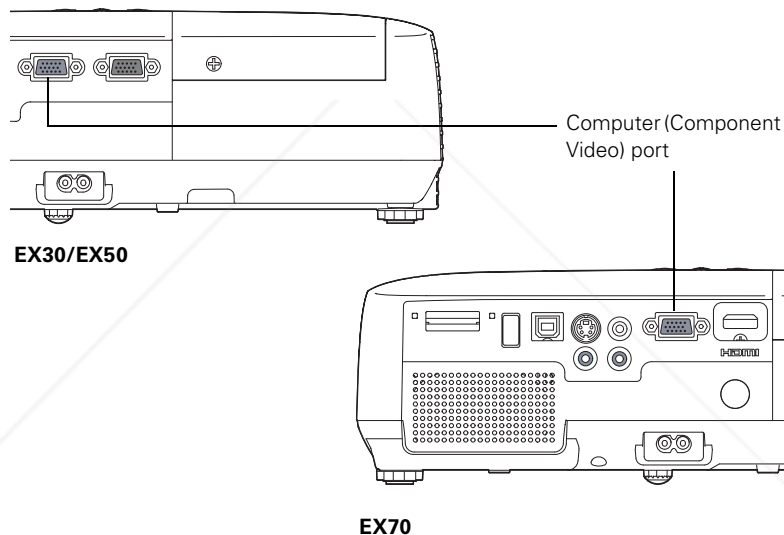

2. You may need to change the Input Signal setting in the projector's Signal menu to RGB (see page 64).
3. You can connect an optional audio cable to play sound through the projector (see page 34).
4. You may also be able to use the remote control as a wireless mouse (see page 53).

When you've finished making connections, see page 37 for instructions on turning on the projector and Chapter 2 for instructions on displaying and adjusting the image.

Connecting to Video Equipment

You can connect several video sources to the projector at the same time. Before starting, look at your video equipment to determine its available video output connections:

- EX70 only: If your video player has an HDMI connector, see “Connecting an HDMI Video Source (EX70 only)” on page 28.
- If your video player has a yellow RCA video output connector, see “Connecting a Composite Video Source” on page 29.
- If your video player has an S-Video connector, see “Connecting an S-Video Source” on page 30.
- If your video player has a component video port (three connectors labeled either Y/Cb/Cr or Y/Pb/Pr), see “Connecting a Component Video Source” on page 31.
- If your video player has an RGB video port, see “Connecting an RGB Video Source” on page 32.

After connecting video cables, you may also want to connect an optional audio cable to play sound through the projector; see page 34.

If you connect using an HDMI cable (EX70 only), the video and sound are both transferred and you won't need to connect any additional cables for audio.

note

If an HDMI cable was not provided with your video device, you can purchase one from an electronics dealer.

Connecting an HDMI Video Source (EX70 only)

For the best image and sound quality, connect your video equipment to the HDMI (High-Definition Multimedia Interface) port, if possible.

Connect an HDMI cable to the HDMI connector on your player and the HDMI connector on the projector.

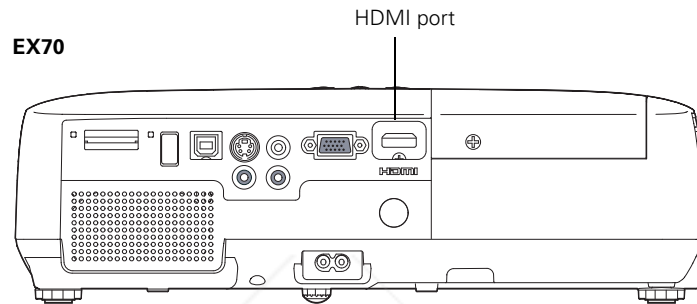

When you've finished making connections, see page 37 for instructions on turning on the projector and Chapter 2 for instructions on displaying and adjusting the image.

Connecting a Composite Video Source

1. If your video cable has an RCA connector, connect it to the yellow video output connector on your player and the yellow Video port on the projector.

EX30/EX50

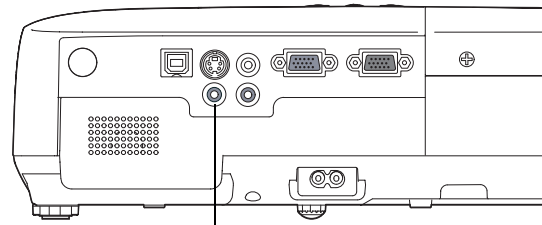

Video port

EX70

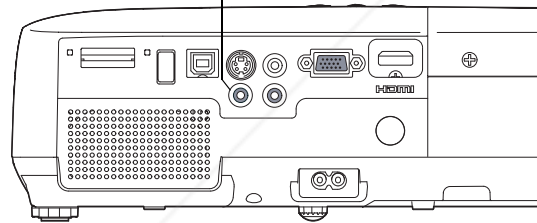

2. If you want to play sound through the projector, see page 34 for instructions on connecting an audio cable.

When you've finished making connections, see page 37 for instructions on turning on the projector and Chapter 2 for instructions on displaying and adjusting the image.

note

If the video cable was not provided with your video device, you can purchase one from an electronics dealer.

note

If the S-Video cable was not provided with your video device, you can purchase one from Epson; see page 12.

Connecting an S-Video Source

1. Connect the S-Video cable to the S-Video connector on your player and the S-Video port on the projector.

EX30/EX50

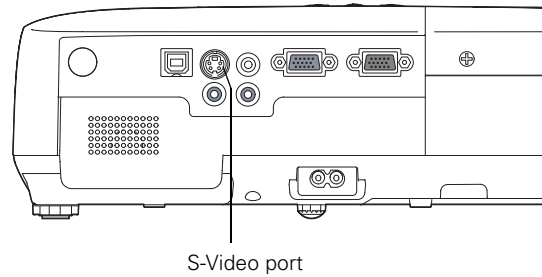

EX70

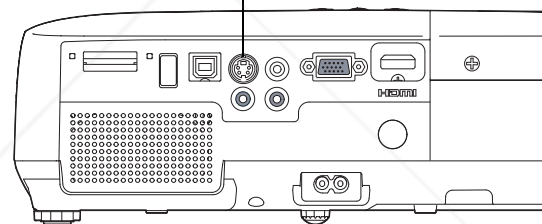

2. If you want to play sound through the projector, see page 34 for instructions on connecting an audio cable.

When you've finished making connections, see page 37 for instructions on turning on the projector and Chapter 2 for instructions on displaying and adjusting the image.

Connecting a Component Video Source

If your video equipment has component video connectors (three connectors labeled either Y/Cb/Cr or Y/Pb/Pr), you can use the component-to-VGA video adapter that came with your projector (EX30 or EX50 only) and a component video cable, or purchase a component-to-VGA video cable from Epson (see page 12) or an electronics dealer.

1. Connect the component end of the cable to the Y/Cb/Cr (or Y/Pb/Pr) connectors on your player.
2. Connect the other end of the cable to the **Computer (Component Video)** port on your projector.

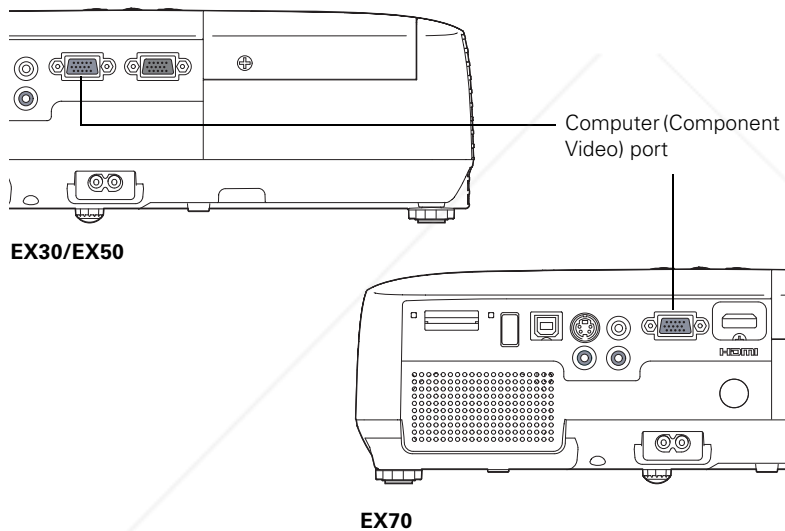

3. You may need to change the **Input Signal** setting in the projector's Signal menu to **Auto** (see page 64).
4. If you want to play sound through the projector, see page 34 for instructions on connecting an audio cable.

When you've finished making connections, see page 37 for instructions on turning on the projector and Chapter 2 for instructions on displaying and adjusting the image.

Connecting an RGB Video Source

You can connect to an RGB video source using the VGA computer cable provided with the projector.

1. Connect the cable to the RGB video port on your player and the Computer (Component Video) port on the projector.

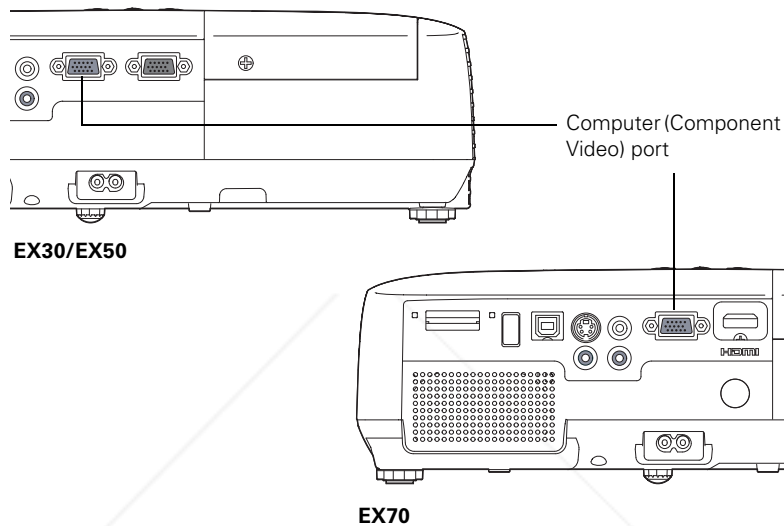

2. You may need to change the **Input Signal** setting in the projector's **Signal** menu to **RGB** (see page 64).
3. If you want to play sound through the projector, see page 34 for instructions on connecting audio cables.

When you've finished making connections, see page 37 for instructions on turning on the projector and Chapter 2 for instructions on displaying and adjusting the image.

Connecting an External Monitor (EX30 or EX50 only)

If you want to monitor your computer presentation close-up (on a monitor placed beside the projector) as well as on the screen, you can connect an external monitor. You can use it to check on your presentation even if you've pressed the **A/V Mute** button or switched to a different picture source.

First make sure your computer's VGA cable is connected to the projector's **Computer (Component Video)** port (see page 26). Then connect your monitor to the projector's **Monitor Out** port, as shown:

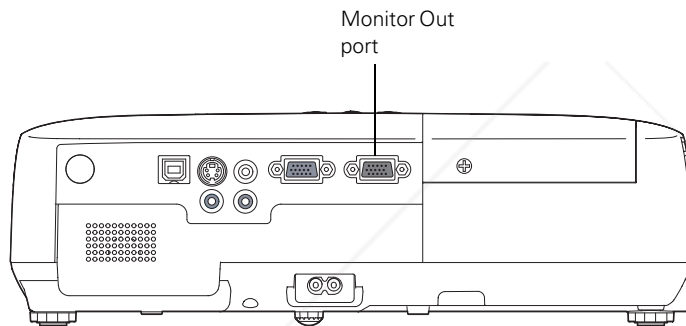

note

Some LCD monitors may not be able to display the image correctly. If you have trouble displaying the image, connect a multiscan monitor. If you're projecting computer images, make sure the computer's refresh rate is set to 65 Hz or greater.

The projector must be turned on for the Monitor Out port to send a signal to the monitor (though it may be in standby mode).

Playing Sound Through the Projector

You can play sound through the projector's speaker system.

1. Locate the appropriate cable and connect it to the Audio jacks on the projector.

EX30/EX50

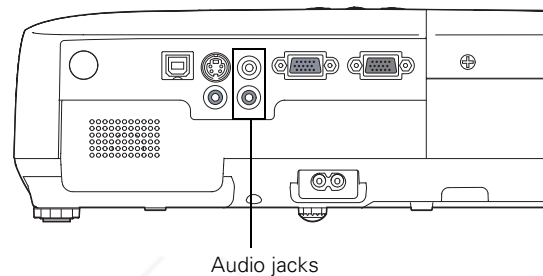

EX70

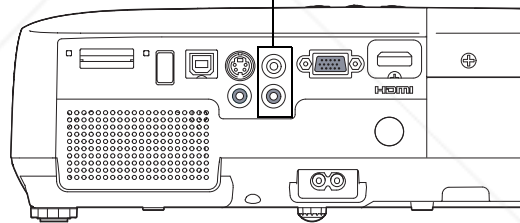

2. Connect the other end of the cable to the audio output connector(s) on your computer or video equipment.

note

Use a cable less than 10 feet (3 meters) long and connect the camera or other device directly to the projector.

Your projector may not function correctly if you use a longer cable or connect to a USB hub.

If you connect a USB hard drive, make sure you use the AC adapter to power the hard drive.

Connecting a Digital Camera or Other USB Device (EX70 Only)

You can connect your digital camera, USB flash memory drive, USB hard drive, or multimedia storage viewer, such as the Epson P-3000 or Apple® iPod® to the projector. Then you can use the projector's Slideshow function to display images or a presentation. See page 55 for details.

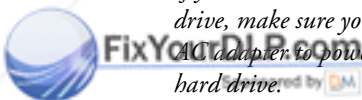

Discount-Merchant.com (800) 281-8860

THE TRUSTED SOURCE FOR PROJECTOR LAMPS AND ACCESSORIES

Use the USB cable specified for your device.

1. Follow the instructions beginning on page 37 to turn on the projector.
2. Connect the USB drive or the flat end of the USB cable to the  USB TypeA port on the projector, as shown.

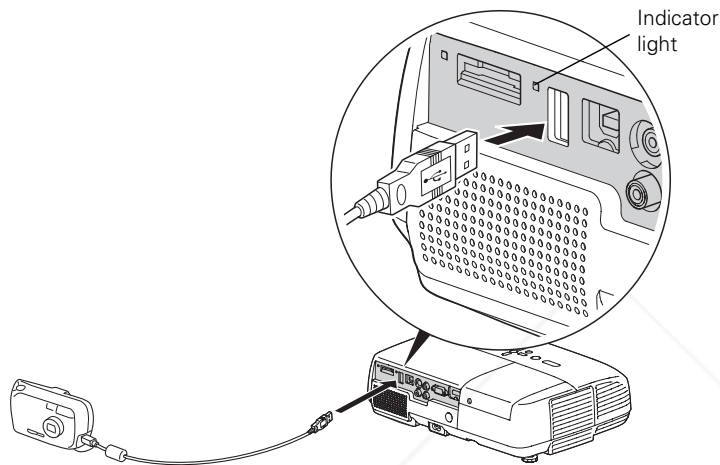

3. Connect the other end of the cable to your camera or other device, if necessary.

The indicator light turns orange and then green when a USB device is connected.
4. If you are not connected to another image source, the Slideshow program appears.

If you are connected to another image source, press the **Slideshow** button on the remote control to start the Slideshow program.
5. See page 55 for instructions on controlling the slideshow.
6. When you're finished, press **Esc** and select **Exit** to exit the Slideshow before turning off or removing the USB device.

Be sure to turn off your USB device (if necessary) before you remove the device or cable from the projector.

Inserting an SD Card (EX70 Only)

You can use an SD or SDHC (SD High Capacity) card to store images or PowerPoint presentation slides converted to .JPG files. This lets you project your files without connecting to a laptop or PC. To place your files on the card, copy them from your computer to the card using a card reader.

1. Follow the instructions beginning on page 37 to turn on the projector.
2. Insert the SD card face-up and contacts-down, and push it all the way into the projector's SD slot:

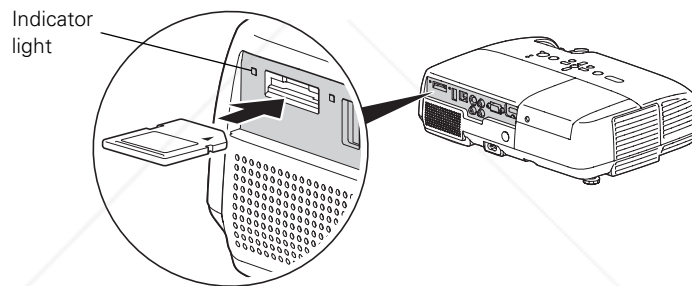

caution

Do not remove the card when the indicator light is flashing, or you may damage the card or projector.

The indicator light beside the slot comes on or flashes when the SD card is in use. Do not remove the card when the light is flashing.

3. If you are not connected to another image source, the Slideshow program appears.
If you are connected to another image source, press the **Slideshow** button on the remote control to start the Slideshow program.
4. See page 55 for instructions on controlling the slideshow.
5. When you're finished, press **Esc** and select **Exit** to exit the Slideshow before removing the SD card.

To remove the card, gently press the inserted SD card. The card pops out so you can remove it.

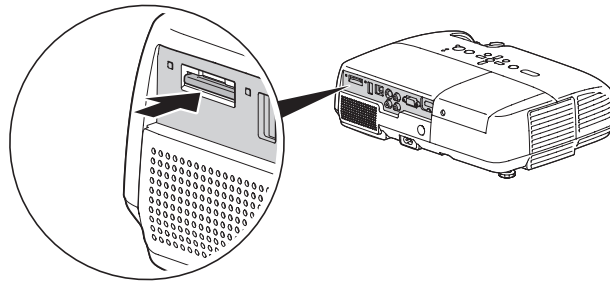

Turning the Projector On and Off

Turn on any connected computer or video equipment before starting the projector so it can automatically detect and display the image source. If you turn on the projector first, or have multiple pieces of connected equipment, you may have to select the image source manually (see page 42).

Follow these steps to turn on the projector:

1. Open the A/V Mute slide (lens cover).



2. Plug one end of the power cord into the projector, and the other end into an electrical outlet.

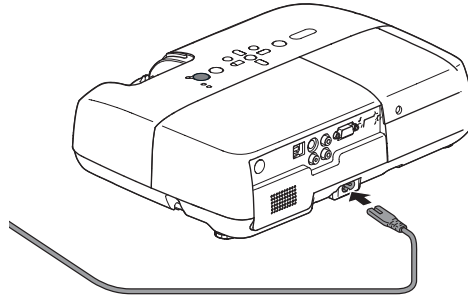

The  power light turns orange.

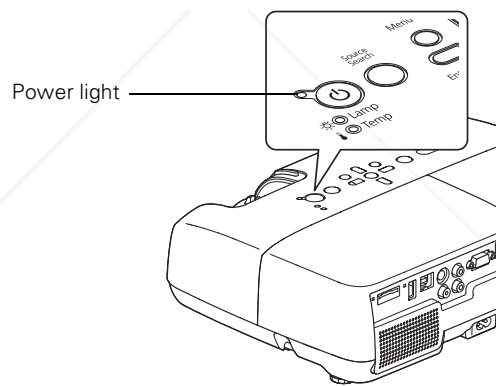

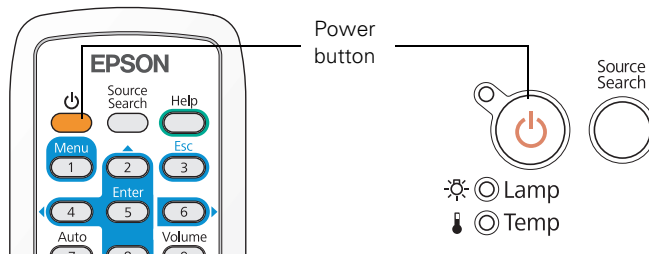

3. Press the  power button on the remote control or on the projector.

EX30/EX50

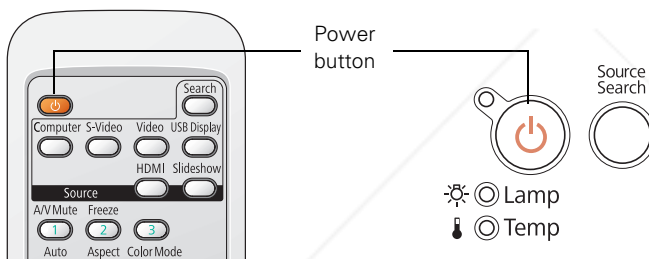

EX70



The projector beeps once and the  power light flashes green as the projector warms up, then an image begins to appear. When the  power light stops flashing and remains green, the projector is ready for use.

4. If you are prompted to enter a password, see page 69.

Using the Direct Power On Function

The Direct Power On function enables faster setup. The projector starts up automatically when you plug it in or turn it on with a wall switch. You don't have to press the  power button.

Follow these steps to enable Direct Power On:

1. Press the **Menu** button on the remote control or projector, then select the **Extended** menu and press **Enter**.
2. Choose **Operation** and press **Enter**.

warning

Never look into the lens when the lamp is on. This can damage your eyes, and is especially dangerous for children.

note

If a power outage occurs when Direct Power On is enabled and the projector is plugged in, the projector will restart when the power is restored.

3. Choose Direct Power On and press Enter.

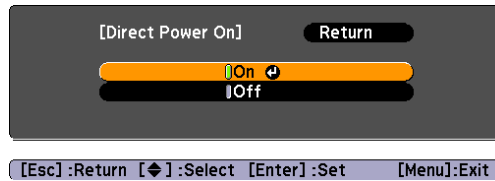

4. Highlight On and press Enter.
5. Press Menu to exit. The setting will take effect the next time you plug in the projector.

note

Lamp life results will vary depending upon mode selected, environmental conditions, and usage.

Turn off this product when not in use to prolong the life of the projector.

You can set the projector to automatically turn off the lamp and enter "sleep mode" when it has not received any signals for 1 to 30 minutes (see page 66). This conserves electricity, cools the projector, and extends the life of the lamp. If you want to start projecting again, press the  power button. If you are done using the projector, unplug the power cord.

Shutting Down the Projector



This projector incorporates Instant Off technology. To turn it off, you can press its  power button as described below, unplug it, or turn off a power switch that supplies power to the projector. You don't have to wait for the projector to cool down first.

1. To turn off the projector, press the  power button on the remote control or projector.

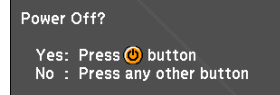
You see a confirmation message.
(If you don't want to turn it off, press any other button.)



2. Press the  power button again. The projection lamp turns off and the projector beeps twice. You can then unplug the power cord.

If you want to turn the projector on again, make sure the orange  power light is not flashing, then press the  power button.

2

Displaying and Adjusting the Image

Follow the guidelines in this chapter for:

- Selecting an image source
- Adjusting the image

Selecting an Image Source

You may need to select the image source if you have multiple image sources connected to the projector (such as a computer or DVD player). Selecting the image source lets you switch between images input from different pieces of connected equipment.

If you don't see the image you want, do one of the following:

- On the EX30 or EX50, press the **Source Search** button on the remote control or the projector until you see the image you want to project.
- On the EX70, press the **Search** button or one of the **Source** buttons on the remote control, or press the **Source Search** button on the projector.

EX30/EX50

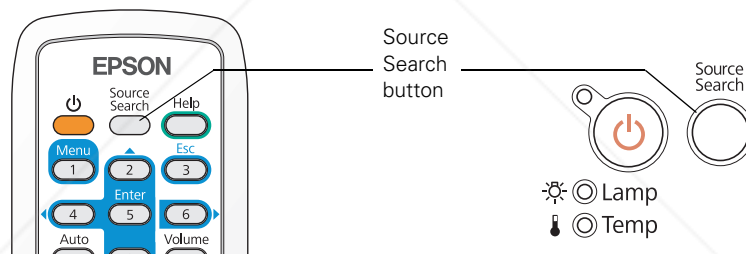

EX70

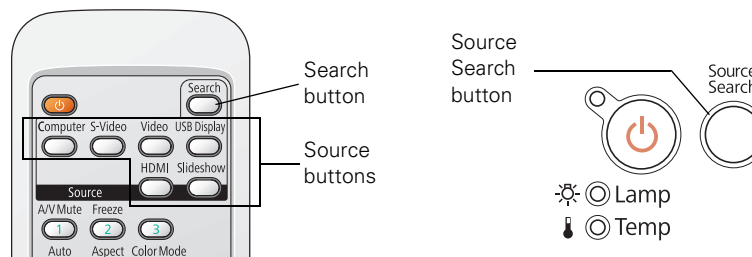

If you still can't see an image or can't project the same image that is on your notebook or computer screen, see page 89 for solutions.

You can also select **Slideshow** to project from a USB device or SD card (EX70 only). See page 55 for instructions.

Adjusting the Image

Once you see your image, you may need to make certain adjustments:

- If the image is too high or too low, reposition it as described below.
- If the image isn't square, see page 44.
- To focus or zoom your image, see page 45.
- To quickly adjust the color, brightness, or contrast, see page 46.
- To change the image aspect ratio, see page 47.
- If you need to fine-tune the image and/or sound, see Chapter 5.

Adjusting the Position of the Image

If the image is too low on the screen, you can use the front adjustable foot to raise it.

1. Press the foot release lever up and lift the front of the projector.

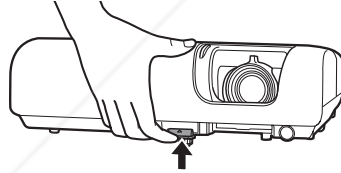

2. Once the image is positioned where you want it, release the lever to lock the foot in position.
3. If the image is tilted or you need to fine-tune the height of the image, you can turn the projector's adjustable rear feet.

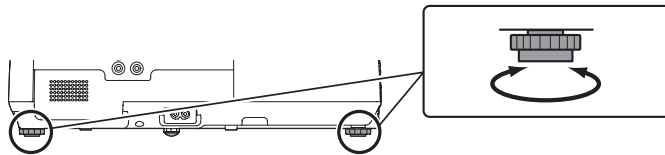

Raising the projector may cause the image shape to distort or "keystone," but you can correct the shape as described on page 44.

Adjusting the Image Shape

You can maintain a rectangular image by placing the projector directly in front of the screen and keeping it level. This also produces the best picture quality. If the projector is tilted up or down (up to 30°), or placed at an angle, the shape may “keystone” and you may need to correct the image shape.

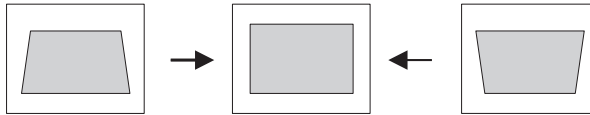

The EX50 and EX70 projectors include an **Auto Keystone** function that detects and corrects vertical keystone distortion up to 11°. It takes about one second after the projector starts for the image to be corrected.

If your image is still distorted, or you are using the EX30 projector, do one of the following:

- Press the appropriate keystone correction button on the projector’s control panel until the shape is evenly rectangular.

EX30

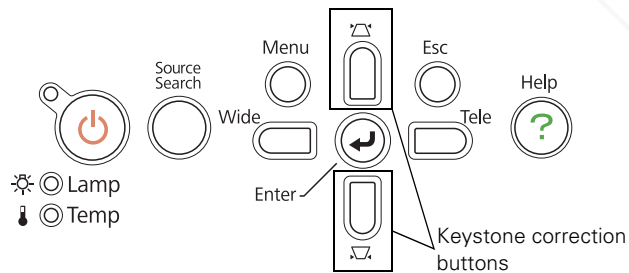

EX50/EX70

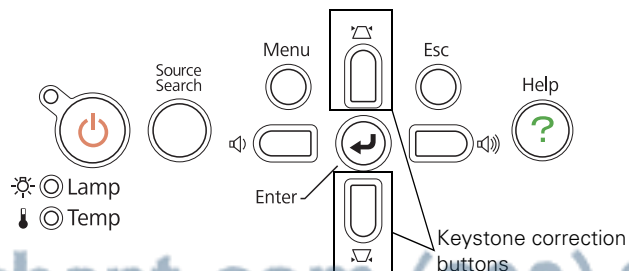

- Select the **Keystone** setting in the projector's **Settings** menu (see page 65). Then use the arrow buttons on the remote control to adjust the shape of the image.

Focusing and Zooming the Image

Turn the focus ring on the projector to sharpen the image.

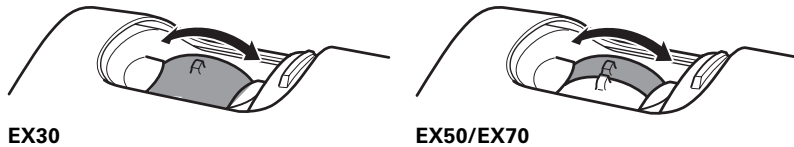

EX50 or EX70: to enlarge or reduce the image, turn the zoom ring.



EX30: to enlarge or reduce the image, press the **Wide** (enlarge) or **Tele** (reduce) button on the projector's control panel. You can also use the **Zoom** setting in the projector's **Settings** menu; see page 65 for instructions.

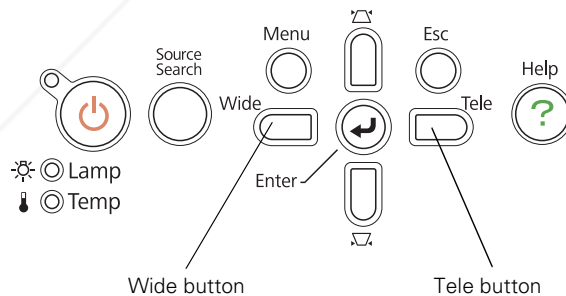

If the image still isn't large enough, you may need to move the projector farther away from the screen.

You can also use the **E-Zoom** buttons on the remote control to zoom in on a portion of the image. See page 51 for instructions.

Selecting the Color Mode

The Color Mode adjusts the brightness, contrast, and color for various common viewing environments. Use this setting to quickly obtain a good picture.

On the EX70, you can press the **Color Mode** button on the remote control to select an option. Press it until the option you want is projected in the upper right corner.

EX70

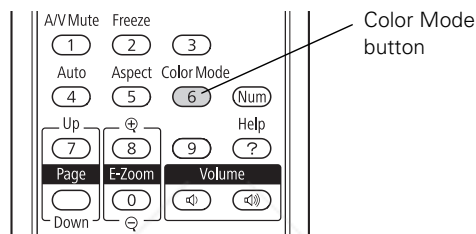

On the EX30 or EX50, you can select the **Color Mode** setting only from the projector's Image menu. See page 61 for instructions.

Select from one of these **Color Mode** options:

- **Game:** Brightest mode; for video games or TV in a bright room.
- **Presentation:** For color presentations in a bright room.
- **Text:** For black-and-white presentations in a bright room.
- **Theatre:** For natural-toned movies in a darkened room.
- **Photo:** For vivid, high-contrast still images in a bright room (only available when the source is set to **Computer** or **USB**, or **Slideshow** [EX70 only]).
- **sRGB:** Matches the color palette of standard sRGB computer displays.
- **Blackboard:** Projects accurate colors on a green chalkboard (adjusts the white point).
- **Sports:** For vivid TV images in a bright room (only available for component video, S-Video, or composite video sources, or HDMI [EX70 only]).

Resizing Video Images

You can resize your images by changing the aspect (width to height) ratio (depending on your input signal).

On the EX70, you can press the **Aspect** button on the remote control. Press the **Aspect** button repeatedly to cycle through the available options.

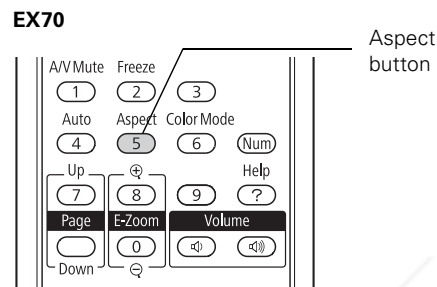

note

You cannot change the aspect ratio when displaying from a computer using the USB TypeB port or from a USB device or SD card using the Slideshow source.

On the EX30 or EX50, you can select the **Aspect** setting only from the projector's Signal menu. See page 63 for instructions.

Select from one of these **Aspect** options:

EX30 or EX50

- **Normal** (for images sent through the Computer (Component Video) port only): Displays images using the full projection area and maintains the aspect ratio of the image. Choose this setting to automatically resize the image and make the best use of the display area.
- **4:3**: Displays images using the full projection area at an aspect ratio of 4:3.
- **16:9**: Converts the aspect ratio of the image to 16:9. 4:3 ratio images are elongated horizontally to fit.

EX70

- **Auto** (HDMI images only): Automatically sets the aspect ratio according to the input signal. Choose this setting to project an HDMI image in the best aspect ratio.

- **Normal** (for images sent through the Computer (Component Video) port only): Displays images using the full projection area and maintains the aspect ratio of the image. Choose this setting to automatically resize the image and make the best use of the display area.
- **16:9**: Converts the aspect ratio of the image to 16:9. 4:3 ratio images are elongated horizontally to fit.
- **Zoom**: Displays images using the full width of the projection area and maintains the aspect ratio of the image. The image may be cut off on the top and bottom depending on its aspect ratio.
- **Full**: Displays images using the full width of the projection area, but does not retain the aspect ratio. 4:3 ratio images are elongated horizontally.
- **Through**: Displays images as is (aspect ratio and resolution are maintained). Black bands may appear or images may be cut off, depending on the resolution.

3

Presenting With the Remote Control

The projector includes a number of tools to enhance your presentation. All of them can be accessed using the remote control, which lets you operate the projector from anywhere in the room—up to 19.7 feet (6 meters) away.

This chapter covers:

- Using the remote control
- Controlling the picture and sound
- Operating your computer with the remote control
- Presenting a slideshow from a USB device or SD card (EX70 only)

note

If a button is pressed for longer than 30 seconds, the remote control stops operating to conserve battery power. When you release the button, normal operation resumes.

Using the remote control under bright fluorescent lamps or in direct sunlight may affect projector response.

Using the Remote Control

Make sure batteries are installed as described on page 82. Follow these tips for using the remote control:

- Point the remote control at the front or back of the projector, or at the screen.
- Stand within 19.7 feet (6 meters) of the projector.
- Aim the remote control within 30° to the side of, or 15° above or below, the remote control receivers on the projector.

Controlling the Picture and Sound

You can use the remote control to temporarily turn off the picture and sound, freeze the action, zoom in on the picture, and adjust the volume.

Turning Off the Picture and Sound

Press the A/V Mute button on the remote control or close the A/V Mute slide on the projector to turn off the image and sound, and darken your screen. This is useful if you want to temporarily re-direct your audience's attention without the distraction of a bright screen.

EX30/EX50

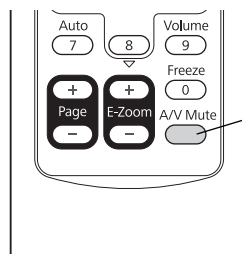

EX70

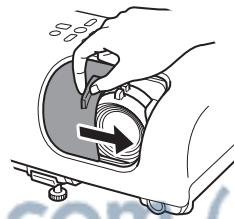
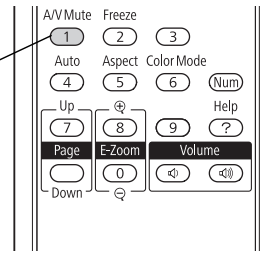

To turn the image and sound back on, press the button again, or open the A/V Mute slide.

You can create an image, such as a company logo or picture, to display on the screen whenever you press the A/V Mute button. (See page 70 for more information.)

You can also set the Lens Cover Timer setting to automatically turn off the projector after 30 minutes to protect the projector if the A/V Mute slide is closed for a long time. See page 66 for instructions.

Stopping Action

Press the Freeze button on the remote control to stop the action in your video or computer image. The image freezes but the sound continues.

To restart the action, press the Freeze button again.

EX30/EX50

EX70

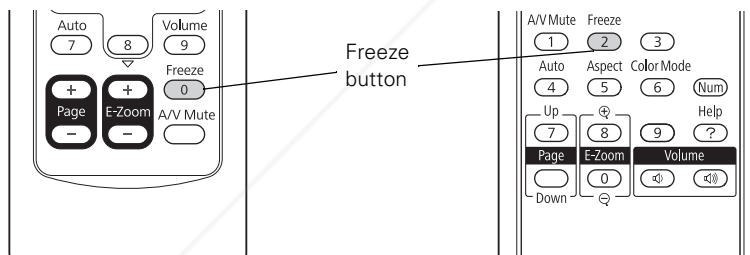

note

The Freeze function pauses the image, not the sound. Because the source continues to transmit signals, it will not resume at the same point.

Zooming In on Your Image

You can zoom in on a portion of the image using the E-Zoom buttons on the remote control.

1. Press the E-ZOOM + button on the remote control.
You see a crosshair indicating the center of the zoom-in area.
2. Use the arrow buttons to position the crosshair.
3. Continue pressing the E-ZOOM + button to enlarge the selected area up to 4 times.
4. While the image is enlarged, you can:

note

You cannot use the Progressive feature (see page 63) while you are using E-Zoom.

- Use the arrow buttons to move around the screen.
 - Press the E-Zoom – button to zoom out.
5. Press the ESC button to return the image to its original size.

Controlling the Volume

To change the volume on the EX30 or EX50 projector, press the Volume button, then press the ► button to increase the volume or the ◀ button to decrease it.

EX30/EX50

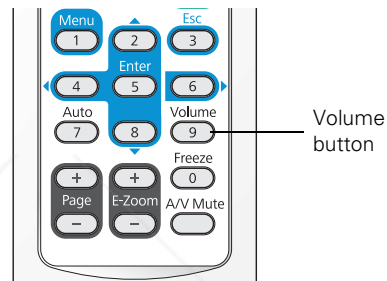

On the EX50 projector, you can also press the ◀ or ▶ button on the projector’s control panel

To change the volume on the EX70 projector, press the ◀ or ▶ button on the remote control or on the projector’s control panel.

note

To temporarily shut off the sound and picture, press the A/V Mute button or close the A/V Mute slide.

EX70

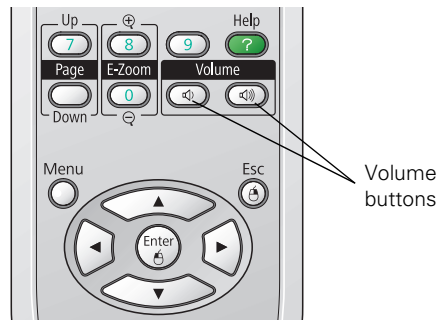

You can also adjust the volume using the projector’s menu system. See page 65.

Operating Your Computer With the Remote Control

You can use the remote control in place of your computer's mouse so you won't have to stand next to the computer to control the presentation.

If you are not using the projector's USB TypeB port to display your presentation, you can use the remote control buttons to do one of the following:

- Move through presentation slides using the **Page Up (+)** or **Page Down (-)** buttons
- Use the buttons as you would a wireless mouse by pressing the arrow, **Enter**, and **Esc** buttons

Before you can use one of these functions, you must connect a USB cable to the USB TypeB port on the projector (see page 24) and select the function you want to use (see page 54).

note

You can use the remote control as a wireless mouse only when projecting from the Computer (Component Video) or HDMI (EX70 only) port.

You may need to select specific settings on your computer to use the remote control as a mouse. See your computer documentation for details.

To control presentation slides using the remote control's Page Up (+) or Page Down (-) buttons, select Page Up/Down as the USB Type B setting on the Extended menu (see page 66). Then you can control your presentation using those buttons.

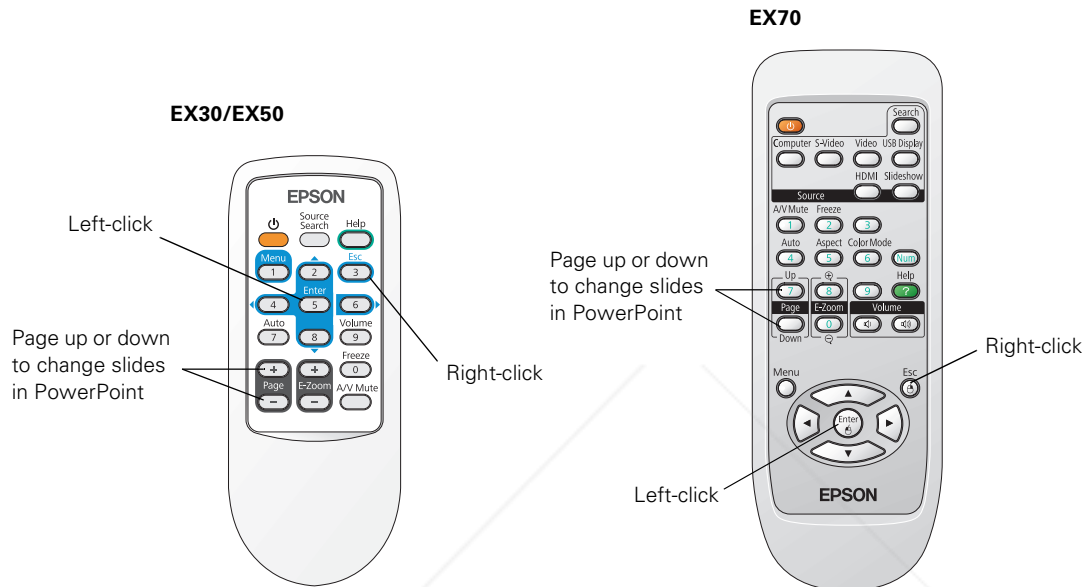

If you want to use the remote control like a wireless mouse, select **Wireless Mouse** as the USB Type B setting on the Extended menu (see page 66). Then you can control your presentation as follows:

- Use the arrow buttons to move the pointer on the screen.
- Press the **Enter** button once to left-click, or twice to double-click. Press the **Esc** button to right-click.
- To drag-and-drop, hold down the **Enter** button. Then use the arrow buttons to drag the object. When it's where you want it, release the **Enter** button.

Presenting a Slideshow (EX70 Only)

You can use your projector's Slideshow feature whenever you insert an SD card or connect a USB device that contains .JPG image files. This lets you quickly and easily display individual images, or start a slideshow of all the images in a folder. You can control your slideshow using the projector remote control.

For an instant PowerPoint presentation, convert your PowerPoint slides to individual .JPG files and store them in a folder. Copy that folder to an SD card, USB flash memory drive, or other USB device. Then connect the device to the projector and begin your presentation.

You can switch the display from the device displaying the slideshow to another source using the **Search** button or one of the specific **Source** buttons on the remote control. To return to the Slideshow source, press **Search** and select **Slideshow**, or simply press the **Slideshow** button.

Starting a Slideshow

1. Connect a USB device to the projector's USB TypeA port (see page 34) or insert a compatible SD card in the SD card slot (see page 36).
2. If you are connected to another image source, press the **Slideshow** button on the remote control to start the Slideshow program.

note

You can project .JPG files in resolutions up to 8176 × 6144, with pixel counts incrementing in multiples of 8.

If the .JPG file is highly compressed, your projector may not be able to display it correctly.

You cannot project movie files using the Slideshow feature.

If you are not connected to another image source, the Slideshow program appears automatically.



3. If you inserted an SD card and connected a USB device at the same time, you see a screen like this:

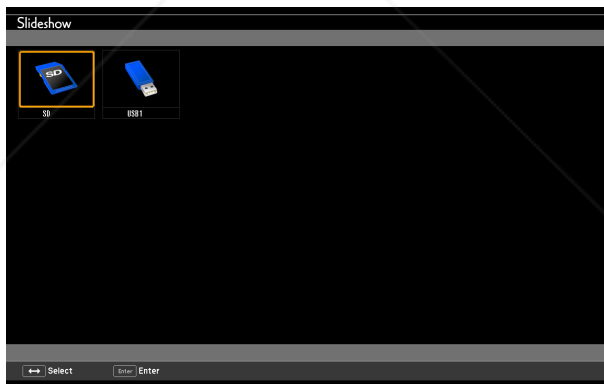

note

To rotate a displayed image, press the ▲ or ▼ button on the remote control until it is displayed correctly.

- Press the arrow buttons on the remote control to highlight the device you want to present from, then press the Enter button.
4. If you need to select a subfolder on your device, press the arrow buttons to highlight the folder and press Enter.
 5. To display an individual image, press the arrow buttons to highlight it and press Enter. To display additional image files, press the ◀ or ▶ arrow button.

- To display a slideshow of all the images in the current folder, use the arrow buttons to highlight **Slideshow** on the bottom of the Slideshow screen and press **Enter**. The images display sequentially one time through. At the end, you see the folder display again.

Select the following as necessary to control your display or slideshow:

- To move back up a folder level, highlight **Back to Top** at the top of the Slideshow screen and press **Enter**.
- To select a different device to display from, highlight **Select drive**, press **Enter**, and select the device.
- If all the images in a folder do not fit on the Slideshow screen, highlight **Next page** and press **Enter** to display the next screen full of images (or select **Previous page** to select the previous screen).
- To exit the slideshow, press **Esc**, select **Exit**, and press **Enter**.

note

*To display a slideshow from a folder that is not open, highlight the folder and press the **Esc** button on the remote control. Then select **Slideshow** from the menu that appears and press **Enter**.*

*To begin a slideshow from a particular image, use the arrow buttons to highlight that image, press **Enter**, then press **Enter** again.*

Selecting Slideshow Display Options

To select slideshow options or add special effects, follow these steps:

- Highlight **Option** at the bottom of the slideshow screen and press **Enter**. You see this screen:

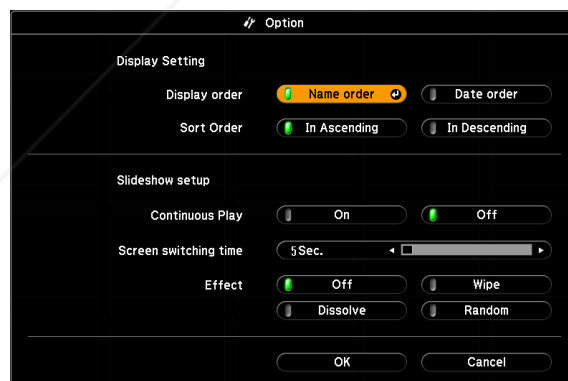

2. Highlight the options you want to use, and press **Enter**.

Option	Available settings
Display order	Name order displays files in name order Date order displays files in date order
Sort order	In Ascending sorts the files first to last In Descending sorts the files last to first
Continuous play	On displays a slideshow continuously Off displays a slideshow one time through
Screen switching time	No does not switch file display automatically 1Sec. to 60Sec. displays files for the selected time and switches them automatically
Effect	Wipe transitions between images with a wipe effect Dissolve transitions between images with a dissolve effect Random transitions between images using a variety of effects in random order

3. When you are finished, highlight **OK** at the bottom of the screen and press **Enter**. (Highlight **Cancel** and press **Enter** to cancel your changes.)

4

Fine-Tuning the Projector

You can use the projector's on-screen menus to adjust the image, sound, and other features. This chapter covers the following information:

- Using the menu system
- Adjusting the image
- Adjusting signal settings
- Customizing projector features
- Customizing power and operation
- Using the projector security features

Using the Menu System

You can use the remote control or the projector's control panel to access the menus and change settings. Follow these steps:

1. To display the menu screen, press the **Menu** button on the remote control or on the projector. You see a menu screen similar to the one below:

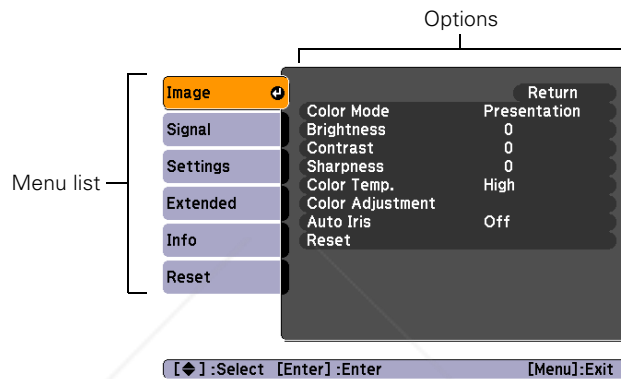

The menus are listed on the left and the options available for the highlighted menu are shown on the right.

2. Use the arrow buttons on the remote control or the projector to scroll through the menu list. When you've highlighted the desired menu, press the **Enter** button to select it.
3. Once you've selected the menu, use the arrow buttons to scroll through the list of options. (Some of the options may be grayed out or unavailable, depending on the selected source.)
4. After highlighting the option you want to adjust, use the arrow buttons to change the setting. In some cases, you may have to press the **Enter** button to view a sub-screen.



- Press the left or right arrow button to adjust a slider bar.
- To select from two or more settings, press the up or down arrow button to highlight the setting and press **Enter**.

5. After changing the settings, press the **Esc** button to save your changes and return to the previous menu (or press it again to exit the menu system). You can also press the **Menu** button to exit.

Restoring the Default Settings

You can use the Reset option on any menu to restore the factory-default settings for the settings in that menu.

To restore all the projector settings to their factory-default values, select the Reset menu, highlight Reset All, press Enter, and select Yes to confirm.

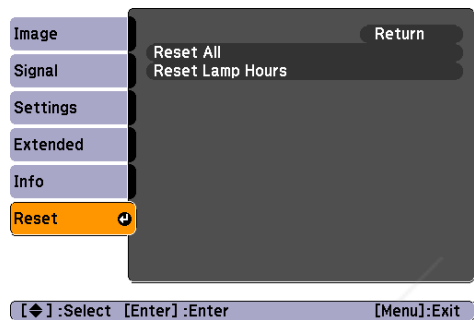

note

When you select Reset All in the Reset menu, it does not reset the Input Signal, User's Logo, Language, or Lamp Hours settings.

Adjusting the Image

You can use the Image menu to adjust the brightness, sharpness, color, tint, contrast, and Auto Iris settings.

1. Press the Menu button on the projector or remote control and select the Image menu. You see a screen similar to one of these:

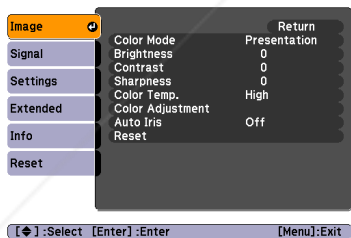

Computer/RGB video

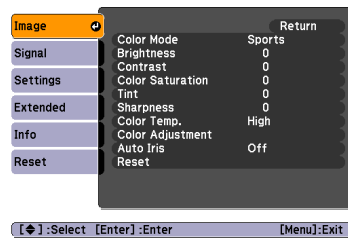

Component video/
Composite video/
S-Video

note

If you are using the HDMI port (EX70 only), you see the menu on the left if the current signal is digital RGB video, or the menu on the right if the signal is component video.

note

The available settings vary depending on the input source selected.

The Brightness setting changes the opacity of the projector's LCD panels. You can also change the lamp's brightness. Select Brightness Control in the Settings menu, then choose High or Low (the default setting is High).

2. Adjust the desired options as needed:

- **Color Mode**
Lets you quickly adjust the color and brightness for various environments. You can save a different setting for each source. See page 46 for a description of each color mode.
- **Brightness**
Lightens or darkens the overall image.
- **Contrast**
Adjusts the difference between light and dark areas.
- **Color Saturation**
Adjusts the color depth of the image.
- **Tint**
Adjusts the balance of green to magenta in the image.
- **Sharpness**
Adjusts the sharpness of the image.
- **Color Temp.**
Sets the color temperature of the image. Select **High** to tint the image bluer or **Low** to tint it redder (default setting is **Medium**). (Not available if **sRGB** is selected as the Color Mode setting.)
- **Color Adjustment**
Adjusts the color values. Select **Red**, **Green**, **Blue** to adjust red, green, and blue hue and saturation values. (Not available if **sRGB** is selected as the Color Mode setting.)
- **Auto Iris**
Automatically adjusts the projected luminance according to the brightness of the image. (Available only when **Game** or **Theater** is selected as the Color Mode for the current input source.)

Adjusting Signal Settings

Although the projector normally detects and optimizes the input signal automatically, you can use the Signal menu to make manual adjustments. In addition to changing the position of the projected image, you can correct tracking and sync for computer images, or change the aspect ratio.

1. Press the **Menu** button and select the **Signal** menu. You see a screen similar to one of those below. (The settings will be different depending on the source you are projecting from.)

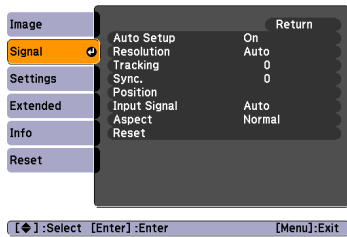

Computer/RGB video

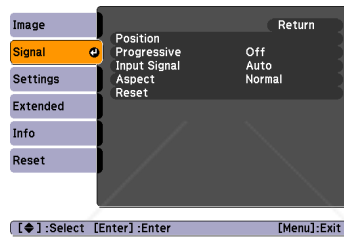

Component video

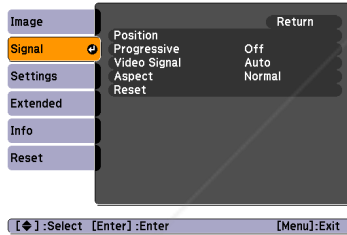

Composite video/S-Video

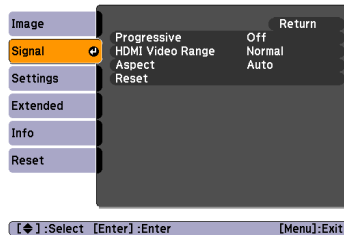

HDMI (EX70 only)

2. Adjust the desired options as needed:
 - **Auto Setup**
Leave this setting **On** to automatically optimize computer images. Turn it off if you want to save adjustments you have made to the Tracking, Sync, and Position settings.
 - **Resolution**
Set to **Auto** to have the projector automatically identify the resolution of the input signal. If necessary, select **Wide** (for widescreen images) or **Normal** (for 4:3 ratio images).

note

You can also use the remote control's **Auto** button to automatically reset the projector's **Tracking**, **Sync**, and **Position** settings. See page 93 for details.

note

You can adjust the **Progressive** setting for signals from the HDMI input port (excluding digital RGB) or component video only when 480i/576i/1080i signals are being input (EX70 only).

The HDMI Video Range setting cannot be set for digital RGB signals (EX70 only).

- **Tracking**
Adjust this value to eliminate vertical stripes in computer images.
- **Sync**
Adjust this value if computer images appear blurry or flicker.
- **Position**
If the image is slightly cut off on one or more sides, it may not be centered exactly. Select this setting and use the arrow buttons to center it.
- **Progressive**
For composite video, S-Video, component video, and certain signals from the HDMI port only (EX70 only). Turn this setting on to convert interlaced signals into progressive signals (best for moving images). Leave the setting **Off** for still images.
- **HDMI Video Range (EX70 only)**
When you connect to the HDMI input port, set the projector's video range to match the video range setting of your device.
- **Input Signal**
If the colors don't look right on the **Auto** setting, select the setting for the type of equipment you've connected to the **Computer (Component Video)** port. Choose **RGB** for a computer or RGB-video connection, or **Auto** for a video player that outputs a component video signal (with connectors labeled Y/Cb/Cr or Y/Pb/Pr).
- **Video Signal (composite or S-Video signals only)**
Select the setting for the type of equipment you've connected to the **Video** port. Leave this setting at **Auto** unless you are using a 60-Hz PAL system (then select **PAL60**).
- **Aspect**
Sets the image's aspect ratio (ratio of width to height). See page 47 for more information.

Customizing Projector Features

You can use the Settings menu to lock the buttons on the projector, adjust audio volume, and customize several other features.

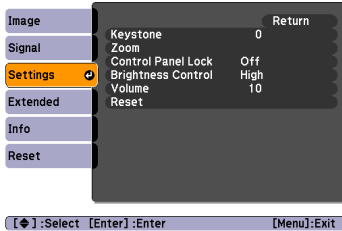

EX30

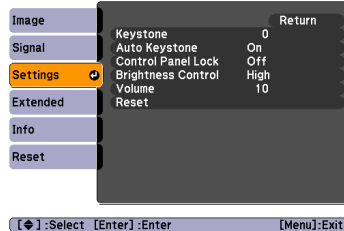

EX50/EX70

■ Keystone

Adjusts the shape of the image if the projector has been tilted upward or downward. If you notice that lines or edge look jagged after adjustment, decrease the **Sharpness** setting (see page 61).

■ Auto Keystone (EX50/EX70 only)

Automatically compensates for keystone distortion when the projector is tilted upward or downward. This feature is available only when the projector is set for front projection (enabled by default).

■ Zoom (EX30 only)

Adjusts the image size from **Wide** (larger) to **Tele** (smaller).

■ Control Panel Lock

Lets you disable all of the buttons on the projector, or all of the buttons except the **⏻** power button. See page 72 for more information.

■ Brightness Control

Lets you select from two levels of brightness. The **Low** setting reduces power consumption and projector noise, and extends the lamp's operating life.

■ Volume

Raises or lowers the volume of the projector's speaker.

Customizing Power and Operation

You can use the Extended menu to customize the way the projector displays images, enable Direct Power On, turn sleep mode on or off, and customize other projector operations.

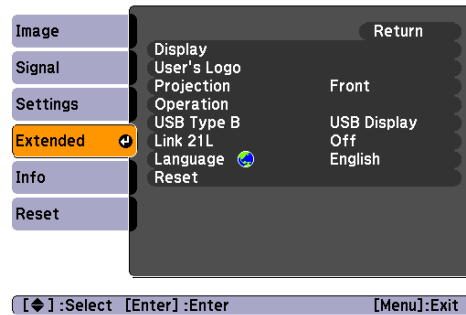

■ Display

Messages: Lets you turn screen messages on or off.

Display Background: Sets the screen background to Black, Blue, or Logo when no image signal is available.

Startup Screen: Enables or disables display of the startup (User's Logo) screen when the projector is turned on.

A/V Mute: Sets the screen background to Black, Blue, or Logo when the A/V Mute button is pressed.

■ User's Logo

Create a custom startup screen, as described on page 70.

■ Projection

Select **Front** (to project from the front of a screen), **Front/Ceiling** (when the projector is mounted upside-down from the ceiling), **Rear** (to project from behind onto a transparent screen), or **Rear/Ceiling** (to project from behind when the projector is mounted upside-down from the ceiling).

■ Operation

Direct Power On: Enable if you want to be able to start the projector when you connect the power cord (without pressing the  power button).

note

If you hold down the A/V Mute button on the remote control for about five seconds, you switch between Front and Front/Ceiling or Rear and Rear/Ceiling.

If Direct Power On is enabled, the power cord is connected, and a power outage occurs, the projector will start when the power is restored.

Sleep Mode: Enable if you want the projector to turn off automatically if it is idle and no signal is received for 1 to 30 minutes (you can adjust the amount of time using the next setting).

Sleep Mode Timer: When Sleep Mode is on, you can set the period of time before the projector turns off automatically, from 1 to 30 minutes.

Lens Cover Timer: Enabled by default to turn the projector's power off automatically when the **A/V Mute** slide is closed for more than 30 minutes.

High Altitude Mode: Enable when you are using the projector above 4,900 feet (1,500 meters) to ensure that the temperature is regulated properly. Turn this setting off for lower elevations.

- **USB Type B**
Select how you want to use the USB port. Select **USB Display** to use the USB port to project computer images. Select **Page Up/Down** to use the remote control to advance PowerPoint slides. Select **Wireless Mouse** to use the remote control buttons like a wireless mouse. See page 53 for restrictions and details.
- **Language**
Select a language to use for the projector menus.

note

Do not use the projector at altitudes above 7,500 feet (2,286 meters).

Using the Projector Security Features

To prevent unauthorized use of the projector, you can:

- Assign a password. You can use the password to prevent the projector from being turned on and prevent your custom startup screen from being changed. See the next section.
- Create a custom screen that is displayed at startup and/or when the **A/V Mute** button is pressed. The screen can be locked with a password to discourage theft and provides a way to identify the projector should it be stolen. See page 70.

- Disable the projector's buttons; this is useful, for example, in a classroom when you want to ensure that no one touches the projector's buttons while you're using the remote control. See page 72.
- Secure the projector to prevent theft using a cable locking system. See page 72.

caution

If you lose the remote control, you will not be able to enter the password. Keep the remote control in a safe place at all times. Also, it's a good idea to write down your password.

Enabling Password Protection

The default setting for the password is 0000. Follow these steps to create a new password:

1. Press the **Freeze** button on the remote control for five to seven seconds. You see this screen:



2. Select the type(s) of password protection you want to use:
 - **Power On Protect:** Prevents unauthorized use of the projector. After the projector is plugged in and turned on, you must enter a password to use the projector. Select **On**, press **Enter**, then press **Esc** to return to the Password Protect screen.
 - **User's Logo Protect:** Prevents your custom screen (see page 70), display, and User's Logo settings in the Extended menu from being changed. Select **On**, press **Enter**, then press **Esc** to return to the Password Protect screen.
3. Use the arrow buttons to select **Password** and press **Enter**.
4. When you see a message asking if you want to change the password, select **Yes** and press **Enter**.
5. Do one of the following to enter your password:

- EX70: Hold down the Num button and use the numeric keypad to enter a four digit password.
 - EX30 or EX50: Use the numeric keypad to enter a four digit password.
6. When you see a confirmation message, reenter the password.
 7. Press the **Menu** button, then press **Enter** to exit the screen.
 8. Turn off and unplug the projector.

EX70

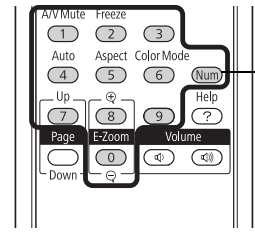

Hold down

Starting the Projector With a Password

When the password function is enabled, you see this screen when you plug in and turn on the projector:

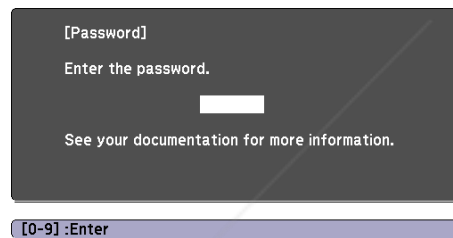

note

If you leave the projector plugged in, the Password screen will not appear. It appears only if you unplug and reconnect the power cord.

Do one of the following to enter the password:

- EX70: Hold down the Num button and use the numeric keypad to enter the four digit password.
- EX30 or EX50: Use the numeric keypad to enter a four digit password.

EX70

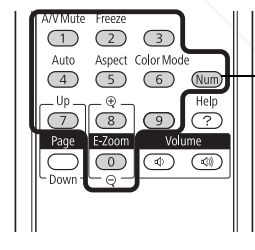

Hold down

The password screen closes and projection begins.

If projection does not begin, check the following:

- If the password is not correct, you see a message prompting you to re-enter the password. If you enter an incorrect password three times in succession, you see an error code with the message **The projector's operation will be locked** and the projector switches to standby mode. Write down the error code, then disconnect the projector's power cord from the electrical outlet, reconnect it, and turn the projector back on. Try entering the correct password again.

- If you have forgotten the password, contact Epson with the request code number that appears in the Password screen for assistance. See “Where To Get Help” on page 96.
- If you enter an incorrect password 30 times in succession, the projector remains locked and you must contact Epson to arrange for service.

Creating Your Own Startup Screen

You can transfer any image from your computer or video source to the projector and then use it as your startup screen. You can also use it as the screen displayed when the projector is not receiving a signal or when you press the A/V Mute button. The image can be a company logo, slogan, photograph, or any other image you want to use.

Capturing the Image

Start by displaying the image you want to use from either a computer or video source, such as a DVD player or digital camera. Then follow these steps to capture the image and transfer it to the projector:

1. Press the **Menu** button on the remote control, highlight the **Extended** menu, and press **Enter**.

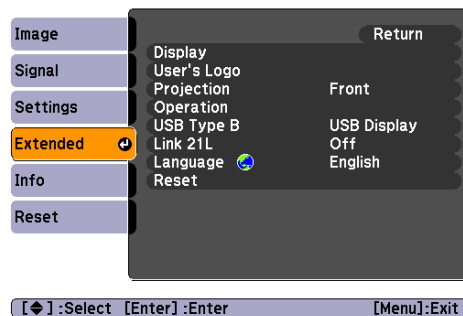

2. Highlight **User's Logo** and press **Enter**.
3. When you see a message asking **Choose this image as the User's Logo?**, select **Yes** and press **Enter**. A selection box displays over the image.

note

When you choose an image for the user's logo, it erases any previously used image. You can save an image up to 300 × 400 pixels in size. Once you have saved a new user's logo, you cannot return to the factory default logo.

4. Use the arrow buttons to select the area of the image you want to use. Then press **Enter**.
5. When you see the message **Select this image?**, highlight **Yes** and press **Enter**.
6. Use the arrow buttons to select a zoom factor (display size) and press **Enter**.
7. When the message **Save this image as the User's Logo?** appears, select **Yes** and press **Enter**. Saving the logo may take a few moments. Do not use your projector, remote control, or video source while the logo is being saved.
8. When you see the message **Completed**, press **Menu** to exit.

Choosing When to Display the Image

After your image is saved, you can set it to display as the startup screen, the screen you see when there's no signal, or the screen you see when you press the **A/V Mute** button (see page 50).

1. Press the **Menu** button, highlight the **Extended** menu, and press **Enter**.
2. Select **Display** and press **Enter**.
3. Choose from these display options:
 - Set **Display Background** to **Logo** to display your image when there is no signal.
 - Set **Startup Screen** to **On** to display your image when the projector is warming up.
 - Set **A/V Mute** to **Logo** to display your image when you press the **A/V Mute** button.
4. When you're finished, press **Menu** to exit.

note

You can lock these settings to prevent them from being changed without a password (see page 68).

Disabling the Projector's Buttons

When you enable the Control Panel Lock function, you can lock all of the projector's buttons, or all of the buttons except the  power button. The remote control can still be used to operate the projector.

1. Press the **Menu** button, highlight the **Settings** menu, and press **Enter**.
2. Select **Control Panel Lock** and press the **Enter** button.
3. Select **Full Lock** (to lock all projector buttons) or **Partial Lock** (to lock all buttons except the  power button) and press **Enter**.

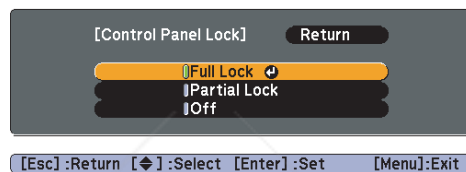

4. Select **Yes** and press **Enter** to confirm the setting.
5. Press the **Menu** button to exit.

To disable the Control Panel Lock function, select **Off** in the Control Panel Lock menu. Or press and hold the **Enter** button on the projector's control panel for seven seconds. A message is displayed and the lock is released.

Using Security Locking

The projector includes two security locking points to prevent its theft when installed or used in public locations:

- **Security cable attachment.** You can attach a commercially available security cable as shown below to secure the projector to a table or ceiling mount.

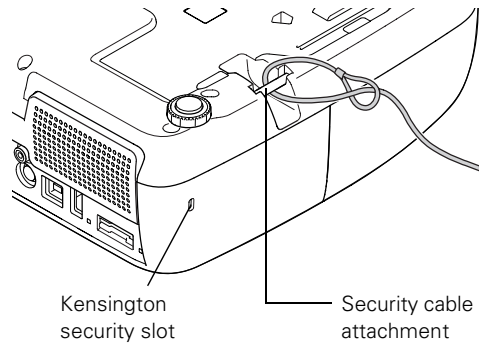

- **Kensington security slot.** The security slot (located on the side of the projector) is compatible with the MicroSaver security systems manufactured by Kensington. You can purchase this lock from Epson (see page 12).



Discount-Merchant.com (800) 281-8860

THE TRUSTED SOURCE FOR PROJECTOR LAMPS AND ACCESSORIES

5

Maintaining the Projector

warning

Before you clean any part of the projector, turn it off and unplug the power cord.

Never open any cover on the projector, except the lamp cover. Dangerous electrical voltages in the projector can injure you severely. Do not try to service this product yourself, except as specifically explained in this User's Guide. Refer all other servicing to qualified service personnel.

Your projector needs little maintenance. All you have to do on a regular basis is clean the lens, and check that the air filter and vents are clean. A clogged air filter or vent can block ventilation needed to cool the projector.

The only parts you should replace are the lamp and air filter. If any other part needs replacing, contact your dealer or a qualified servicer.

This chapter covers the following:

- Cleaning the lens
- Cleaning the projector case
- Cleaning the air filter
- Replacing the air filter
- Replacing the lamp
- Replacing the remote control batteries
- Transporting the projector

caution

Do not rub the lens with harsh materials or subject the lens to shocks, or you may damage it.

Do not use wax, alcohol, benzene, paint thinner, or other chemical detergents. These can damage the case.

note

To order replacement air filters, request part number V13H134A13. See page 12 for ordering information.

Cleaning the Lens

Clean the lens whenever you notice dirt or dust on the surface.

To remove dirt or smears on the lens, use a commercially available cloth for cleaning glasses.

Cleaning the Projector Case

Before cleaning, turn off the projector and unplug the power cord.

- To remove dirt or dust, wipe the case with a soft, dry, lint-free cloth.
- To remove stubborn dirt or stains, moisten a soft cloth with water and a neutral detergent and firmly wring the cloth dry. Then wipe the case.

Cleaning the Air Filter

Your projector includes an air filter to ensure the best performance. If dust collects on the air filter, clean it as described here. Dust clogs prevent proper ventilation and can cause overheating, which can damage the projector.

1. Turn off the projector and unplug the power cord.
2. Remove dust from the air filter using a small vacuum cleaner designed for computer or office equipment, or gently clean the vent with a soft brush (such as an artist's paintbrush).

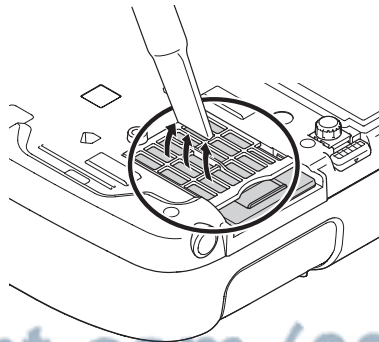

You can remove the air filter to clean both sides

If the filter is too dirty or broken, replace the filter as described below.

Replacing the Air Filter

You need to replace the air filter if:

- You cannot remove the dust from it
- The air filter is damaged or torn
- You repeatedly see a projected message telling you to clean or replace it

Contact your dealer or call Epson at 800-GO-EPSON (800-463-7766) to obtain a new air filter. Request part number V13H134A13.

1. Turn off the projector and unplug the power cord.
2. Slide the air filter out of its slot as shown.

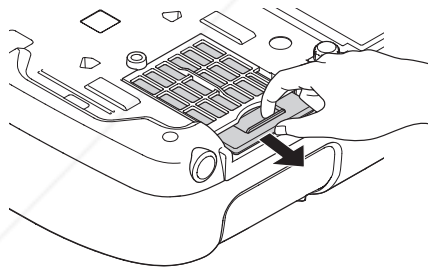

3. Slide the new air filter into the slot until it clicks into place.

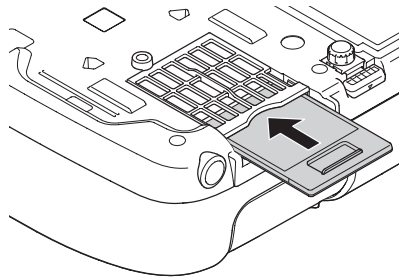

note

Air filters contain polycarbonate, ABS resin, and polyurethane foam. Dispose of used air filters according to local regulations.

note

Turn off this product when not in use to prolong the life of the projector.

warning

Let the lamp cool fully before replacing it.

In the unlikely event that the lamp has broken, small glass fragments may be present and should be removed carefully to avoid injury. If the projector has been installed on the ceiling, you should stand to the side of the lamp cover, not underneath it.

If the lamp is used after the replacement period has passed, the possibility that the lamp may break increases. When a lamp replacement message appears, replace the lamp with a new one as soon as possible, even if it is still working.

Replacing the Lamp

The life span of the projection lamp is about 3000 hours if **Brightness Control** in the Settings menu is set to **High** (default), and 4000 hours if **Brightness Control** is set to **Low**. See page 81 to check the lamp usage.

It is time to replace the lamp when:

- The projected image gets darker or starts to deteriorate.
- The message **Replace the lamp** appears on the screen and the  **Lamp** light flashes orange. To maintain projector brightness and image quality, replace the lamp as soon as possible.

You may also need to replace the lamp if the  **Lamp** light flashes or stays on red. See page 87.

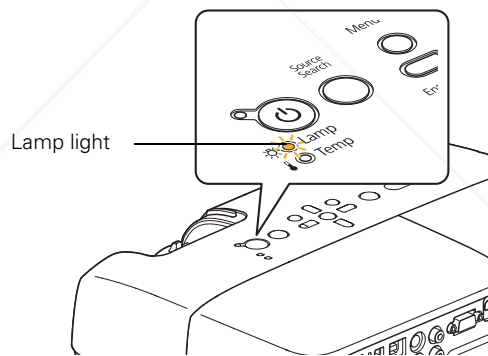

Contact your dealer or call Epson at 800-GO-EPSON (800-463-7766). Request part number V13H010L41.

Follow these steps to replace the lamp:

1. Turn off the projector and, after the projector beeps twice, unplug the power cord.
2. Let the projector cool for at least an hour (if it has been on). The lamp is extremely hot immediately after use.

3. Loosen the lamp cover screw (you cannot remove it). Then slide the lamp cover off.

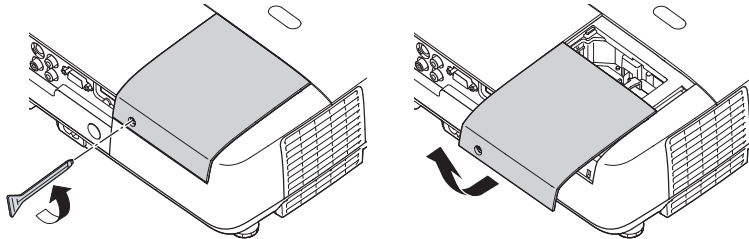

4. Loosen the two screws holding the lamp in place (you can't remove them).

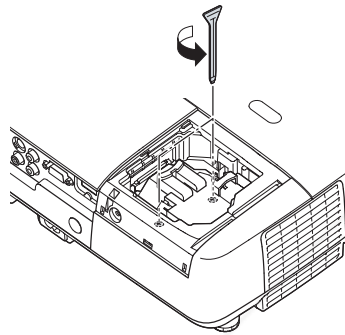

Loosen, but don't remove these screws

5. Hold the lamp as shown and pull it straight out.

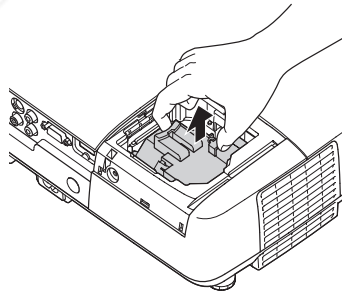

note

(Hg) *The lamp(s) in this product contain mercury. Please consult your state and local regulations regarding disposal or recycling. Do not put in the trash.*

6. Gently insert the new lamp. (If it doesn't fit easily, make sure it is facing the right way.) Then tighten its screws.

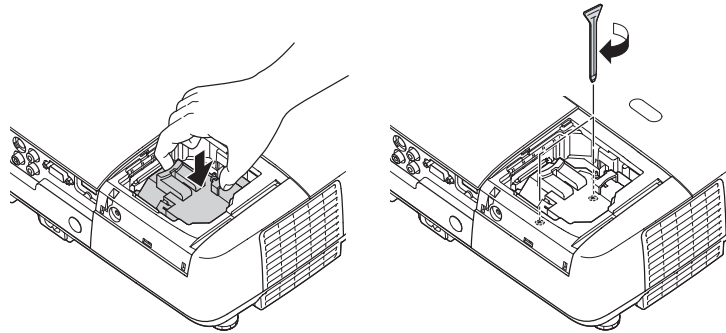

note

Tighten the lamp cover securely so you do not receive a lamp cover error when you turn the projector back on.

7. Replace the lamp cover, then tighten its screw.

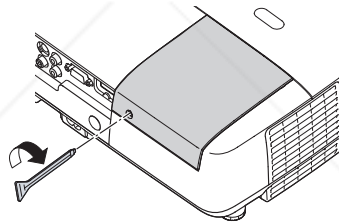

8. Reset the lamp timer as described in the next section.

Resetting the Lamp Timer

After you replace the lamp, you need to reset the lamp timer using the projector's menu system.

1. Press the **Menu** button on the remote control or on the projector's control panel. You see the main menu.

2. Select the **Reset** menu and press **Enter**. You see this screen:

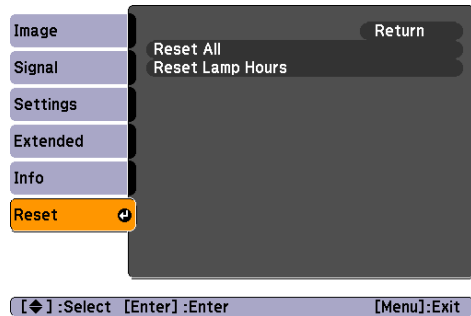

3. Select **Reset Lamp Hours** and press **Enter**.
4. When you see the prompt, select **Yes** and press **Enter**.
5. When you're finished, press **Menu** to exit.

Checking Lamp Usage

To check the number of hours the lamp has been used, press the **Menu** button and highlight the **Info** menu. You see a screen like this:

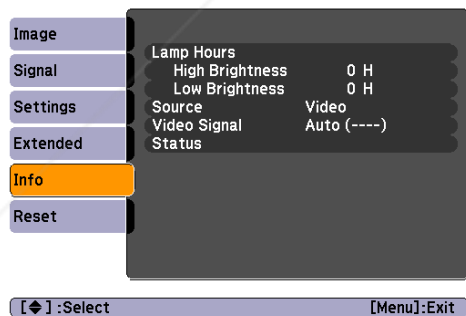

note

The information displayed depends on the input signal currently selected.

If you have used the projector for less than 10 hours, the hours are listed as 0H.

The life span of the lamp is about 3000 hours if the **Brightness Control** setting in the **Settings** menu is set to **High** (default), and 4000 hours if the **Brightness Control** setting is set to **Low**. Make sure you have a spare lamp handy if the usage hours on this menu are close to the life span of your lamp.

Replacing the Remote Control Batteries

caution

When replacing batteries, take the following precautions:

■ Replace the batteries as soon as they run out. If the batteries leak, wipe away battery fluid with a soft cloth. If fluid gets on your hands, wash immediately.

■ Do not expose batteries to heat or flame.

■ Dispose of used batteries according to local regulations.

■ Do not use batteries other than those specified in this User's Guide and do not use batteries of different types or mix old and new batteries.

■ Keep these batteries out of the reach of children. Batteries are choking hazards and are very dangerous if swallowed.

Replace the batteries in the remote control as described below:

1. Turn the remote control over.
2. Press in on the catch on the battery cover as you lift the cover off.

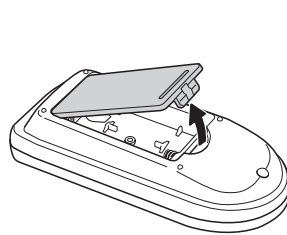

EX30/EX50

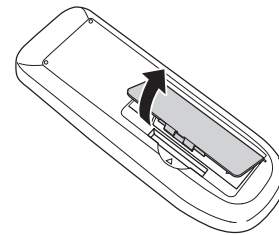

EX70

3. Install two AA alkaline batteries, inserting the + and - ends as shown.

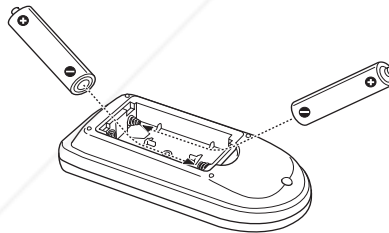

EX30/EX50

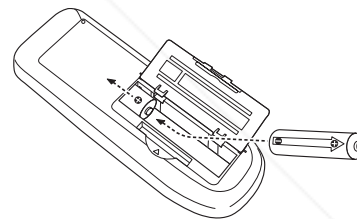

EX70

4. Replace the battery cover and press it down until it clicks into place.

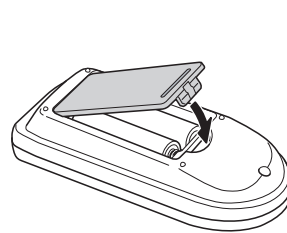

EX30/EX50

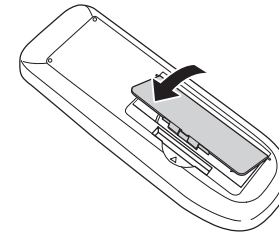

EX70

Transporting the Projector

The projector contains many glass and precision parts. When hand-carrying the projector, use the carrying case.

Follow these guidelines to prevent damage when transporting it:

- When shipping the projector for repairs, use the original packaging material if possible. If you do not have the original packaging, use equivalent materials, placing plenty of cushioning around the projector.
- When transporting the projector a long distance, first place it in a hard-shell shipping case, then pack it in a firm box with cushioning around the case.
- Close the A/V Mute slide (lens cover).
- If an SD card is installed or a USB device is connected, remove it from the projector (EX70 only).
- Return the projector feet to their stored (highest) positions.

note

Epson shall not be liable for any damages incurred during transportation.



Discount-Merchant.com (800) 281-8860

THE TRUSTED SOURCE FOR PROJECTOR LAMPS AND ACCESSORIES

6

Solving Problems

This chapter helps you solve problems with your projector and tells you how to contact technical support for problems you can't solve yourself. The following information is included:

- Using the projector's on-screen help system
- What to do when the projector's status lights flash
- Solving projector operation problems
- Solving problems with the image or sound
- Solving problems with the remote control
- Contacting technical support

Using On-Screen Help

If the image doesn't look right or your audio isn't working, you can get help by pressing the ? Help button on the projector or the remote control.

1. Press the ? Help button on the remote control or on the projector.

You see the Help menu:

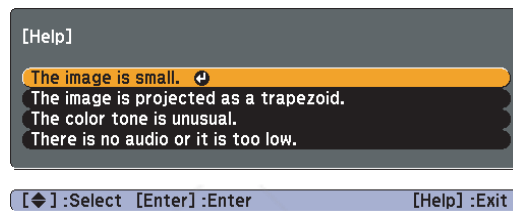

2. Use the arrow buttons on the remote control or the projector to highlight menu items.
3. Press the Enter button on the remote control or the projector to select the menu item and read the solutions.
4. To exit the help system, press the ? Help button.

If none of the suggestions solve your problem, see additional solutions to problems in the following sections.

Checking Projector Status

If your projector isn't working correctly, first turn it off and unplug it. Then plug the power cord back in and turn on the projector. If this doesn't solve the problem, check the lights on top of the projector.

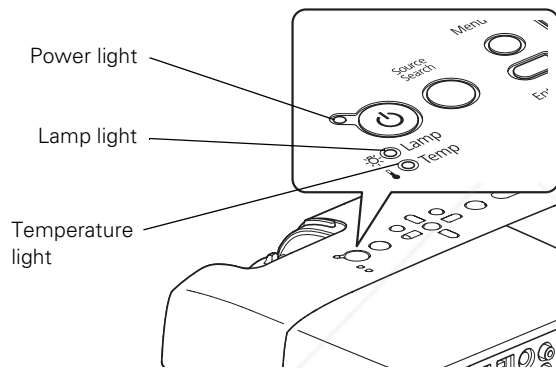

What To Do When the Lights Flash

The lights on top of the projector indicate the projector's status.



Refer to the following tables for a complete description of the projector's status lights:

Power light status



 Power light status	Description
Flashing green	The projector is warming up. Wait for the image to appear.
Green	The projector is operating normally.
Orange	The projector is in sleep or standby mode. You can unplug it or press the  power button to turn it on.
Red, flashing red, or orange	There is a problem with the projector. Check the next table to diagnose the problem.

Error light(s) status

Error light(s) status	Description
<p>☺ Green or orange ⚠ Flashing orange 🚫 Off</p>	<p>It's time to replace the lamp. See page 78 for instructions. If you continue to use the lamp after the replacement warning, there is an increased possibility that the lamp may break.</p>
<p>☺ Red ⚠ Off 🚫 Flashing orange</p>	<p>Rapid cooling is in progress. Although this is not an abnormal condition, projection will stop automatically if the temperature rises higher. Make sure there is plenty of space around and under the projector for ventilation, and that the air filter and vents are clean.</p>
<p>☺ Red ⚠ Off 🚫 Red</p>	<p>The projector is overheating, which turns the lamp off automatically. Wait until the projector switches to standby mode (about 5 minutes). Make sure there is plenty of space around and under the projector for ventilation. The air filter may be clogged. Clean or replace the air filter as described on pages 76 to 77.</p> <p>If you're using the projector above an altitude of 4,900 feet (1,500 meters), turn on High Altitude Mode in the Operation menu (see page 66).</p> <p>If the projector continues to overheat after you clean the air filter, stop using the projector, disconnect the power cord, and contact Epson for help as described on page 96.</p> <p>Warning: Except as specifically explained in this <i>User's Guide</i>, do not attempt to service this product yourself.</p>
<p>☺ Flashing red ⚠ Off 🚫 Flashing red</p>	<p>The projector has an internal problem. Stop using the projector, disconnect the power cord, and contact Epson for help, as described on page 96.</p>
<p>☺ Red ⚠ Off 🚫 Flashing red</p>	<p>There is a problem with the fan or temperature sensor. Stop using the projector, disconnect the power cord, and contact Epson as described on page 96.</p>
<p>☺ Red ⚠ Flashing red 🚫 Off</p>	<p>The lamp may be burnt out. First make sure the lamp cover is securely installed. If that's not the problem, the air filter may be clogged. Clean or replace the air filter as described on pages 76 to 77.</p> <p>If this does not resolve the problem, let the lamp cool and then remove it. If the lamp is cracked, replace it as described on page 78. If the lamp is not cracked, reinstall it. If reinstalling doesn't work, replace the lamp.</p> <p>If you're using the projector above an altitude of 4,921 feet (1,500 meters), turn on High Altitude Mode in the Operation menu (see page 66).</p> <p>If none of these suggestions resolves the problem, contact Epson as described on page 96.</p>

Solving Projector Operation Problems

The power doesn't turn on.





- If the projector doesn't turn on when you press the  power button, make sure the power cord is connected to the projector and plugged into a working electrical outlet.
- The power cord may be defective. Disconnect the cord from the outlet and contact Epson as described on page 96.
- If you're using the Direct Power On function and you immediately plug the power cord back in after unplugging it, the power may not turn back on. Press the  power button to turn the projector back on.

The buttons on the projector don't work.

If the Control Panel Lock function has been enabled, you can't use the buttons on the projector. Try using the remote control instead, or press and hold the projector's **Enter** button for seven seconds to release the lock (see page 72).

Solving Problems With the Image or Sound

No image appears on the screen.

- Check that the  power light is green (not flashing) and that the A/V Mute slide is open. Also press the **A/V Mute** button on the remote control to make sure the picture has not been turned off temporarily.
- The projector may be in standby or sleep mode. If the  power light is orange, press the  power button to turn the projector on.
- If the power was switched off and then on again, the projector may be cooling down. Wait until the  power light stops flashing and remains orange; then press the  power button again.



FixYourDLP.com

Sponsored by

Discount-Merchant.com (800) 281-8860

THE TRUSTED SOURCE FOR PROJECTOR LAMPS AND ACCESSORIES

Solving Problems

89

- The attached computer may be in sleep mode or displaying a black screen saver. Try pressing a key on the computer.
- If you are projecting from a DVD player or other video source, make sure you turn it on and press its **Play** button.
- If you are projecting from a composite or S-Video video source, make sure the Video Signal setting is correct (see page 63).
- You can also try resetting all of the menu settings (see page 61).

You've connected a computer and see a blue screen with the message No Signal displayed.

- Make sure the cables are connected correctly, as described beginning on page 24.
- If you've connected a computer and one or more video sources, you may need to press the **Search** or **Source Search** button to select the correct source. Allow a few seconds for the projector to sync up after pressing the button.
- Make sure the power for your connected equipment is turned on.

If you're using a PC notebook:

- Hold down the **Fn** key on the keyboard and press the function key that lets you display on an external monitor. It may have an icon such as , or it may be labelled **CRT/LCD**. Allow a few seconds for the projector to sync up after pressing it. Check your notebook's manual or online help for details.

On most systems, the  key lets you toggle between the LCD screen and the projector, or display on both at the same time.

If you connect the notebook while the projector or computer are already turned on, the function **Fn** key that changes the computer's image signal to external output may not work. Turn the computer and the projector off and then back on again.

- Depending on your computer's video card, you might need to use the Display utility in the Control Panel to make sure that both the LCD screen and external monitor port are enabled. See your computer's documentation or online help for details.

If you're using Mac OS X:

1. Open System Preferences.
2. Click Displays.
3. Click Detect Displays.
4. Make sure the VGA Display or Color LCD dialog box is selected.
5. Click the Arrangement or Arrange tab.
6. Make sure the Mirror Displays checkbox is selected.

The message Not Supported is displayed.

- Make sure the correct input signal is selected in the Signal menu (see page 63).
- Make sure your computer's resolution and frequency or refresh rate is supported by the projector (see page 103). If necessary, change your computer's settings.

Only part of the computer image is displayed.

- Press the **Auto** button on the remote control or the **Enter** button on the projector.
- Make sure the image **Position** setting is correct in the Signal menu. See page 64 for more information.
- Press the **Aspect** button on the remote control (EX70 only) or select the correct **Aspect** setting from the Signal menu. See page 47 for details on the available options.
- Press the **Esc** button on the remote control to cancel the E-Zoom function.
- Make sure your computer's resolution setting is correct. See the compatible video formats listed on page 103.
- You also may need to modify existing presentation files if you created them for a different resolution. See your software documentation for specific information.

- If you're projecting a widescreen computer image, adjust the **Resolution** setting (see page 63), if necessary.
- If you're projecting an image from a computer with dual display activated, turn dual display off.

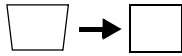

The image isn't square, but keystone-shaped.

If the image isn't evenly rectangular, adjust its shape as described on page 44.

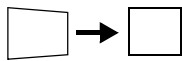

The image contains static or noise.

- If you're using a computer cable longer than 6 feet (1.8 meters), or an extension cable, the image quality may be reduced.
- Keep your computer and video cables away from the power cord as much as possible to prevent interference.
- The video signal may be split between the computer and the projector. If you notice a decline in the projected image quality when the image is displayed simultaneously on your notebook computer and the projector, turn off the notebook's LCD display.
- Make sure the correct input signal is selected in the Signal menu (see page 64).
- If you're using a composite, S-Video, or component video source with 480i signals, turn on the **Progressive** setting on the Signal menu (see page 64).
- If you've used the Keystone adjustment, you may need to decrease the **Sharpness** setting in the Image menu (see page 62).
- If you're projecting from a computer, make sure its signal is compatible with the projector. See page 103.
- If you're projecting from a computer, press the **Auto** button on the remote control to reset the projector's Tracking, Sync, and Position settings.

The image is blurry.

- There may be dirt or smears on the lens. Clean the lens as described on page 76.
- Adjust the focus using the focus ring (see page 45).
- If the projector is angled sharply toward the screen, it may not be possible to focus the entire image. Move the projector to position it more directly in front of the screen.
- Lower the projection angle to reduce the amount of keystone correction required.
- Make sure the projector is within the proper range (projection distance) from the screen (see page 17).
- Make sure the lens is not fogged by condensation. You may need to wait before using the projector after moving it from a cold environment to a warm environment.
- If you're projecting from a computer, you may need to adjust the tracking and sync settings as described in the next section.

You see vertical bands or the image still looks blurry after trying the solutions in the previous section.

- If you're projecting from a computer and displaying an image that contains a lot of fine detail, you may notice vertical bands or some of the characters may look heavy or blurred. Press the **Auto** button on the remote control or the **Enter** button on the projector to reset the projector's Tracking, Sync, and Position settings.
- If further adjustment is needed, you can fine-tune the Tracking and Sync settings manually using the Signal menu, as described on page 64.
 1. Fill the screen with an image containing fine detail, such as a pattern to appear as your desktop background, or try projecting black text on a white background.

note

You must be projecting an image for the Auto button to have any effect. It works only with computer images projected through the Computer (Component Video) port.

2. Adjust the Tracking to eliminate vertical bands.

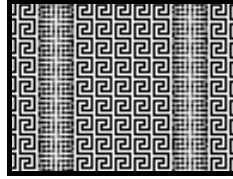

3. Adjust the Sync setting to increase the image sharpness.

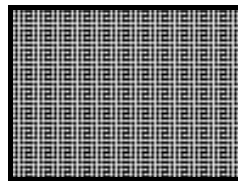

note

Because of the different technologies used, your projected image may not exactly match the colors on your notebook or computer monitor.

The image is too light or dark, or colors are incorrect.

- Press the Color Mode button (EX70 only) or select a different Color Mode option in the Image menu. See page 46 for details on the available options.
- If you're displaying video, adjust the Color Adjustment and Color Mode settings on the Image menu. You can also try adjusting the Color Saturation, Color Temp, and Tint settings on the Image menu.
- Try adjusting the Brightness and Contrast settings on the Image menu.
- Try adjusting the Brightness Control setting (see page 65).
- Check your computer display settings to correct the color balance.
- The projector's lamp may need to be replaced. See page 78 for instructions.
- Make sure the correct input signal is selected in the Signal menu (see page 64).
- Make sure that all cables are connected to the proper ports and connected securely.

There is no sound, or the sound is not loud enough.

- Use the **Volume** buttons to adjust the volume (see page 52), or adjust the **Volume** setting in the Settings menu.
- Make sure **A/V Mute** is not enabled. (Press the **A/V Mute** button to disable it.)
- If your presentation includes computer audio, make sure the volume control on your computer is not turned all the way down or muted. In Windows, you may be able to check this by clicking the volume control in your Windows system tray (lower right corner of the screen). On a Mac, you may be able to adjust the volume from your menu bar (top right corner of the screen) or via the volume control function keys.
- If you're using a DVD player or other video source, make sure the cables are connected correctly, as described on page 34.

Nothing appears on an external monitor (EX30 and EX50 only)

The only images that can be displayed on an external monitor are computer images connected through the **Computer (Component Video)** port (see page 33).

Solving Problems With the Remote Control

The projector doesn't respond to remote control commands.

- Point the remote control towards the projector's receiver. Make sure you are within 19.7 feet (6 meters) of the projector and within a 30° horizontal angle and a 15° vertical angle from the projector's front or back receiver.
- The remote control's batteries may not be installed correctly or may be low on power. To change the batteries, see page 82.

- Dim the room lights and turn off any fluorescent lights. Make sure the projector is not in direct sunlight. Strong lighting, especially fluorescent lights, may affect the projector's infrared receivers. Also, turn off any nearby equipment that emits infrared energy, such as a radiant room heater.
- If any buttons are held for longer than 30 seconds, the remote enters sleep mode. Release any button that is held to wake the remote.

Where To Get Help

Epson provides these technical support services:

Internet Support

Visit Epson's support website for solutions to common problems with the [EX30](#), [EX50](#), or [EX70](#). You can download utilities and documentation, get FAQs and troubleshooting advice, or e-mail Epson with your questions.

Visit [Presenters Online](#) to access tips, templates, and training for developing successful presentations.

Speak to a Support Representative

To use the Epson PrivateLine Support service, call (800) 637-7661 and enter the PIN on the included Epson PrivateLine Support card. This is the fastest way of speaking to a live representative, and it's free. This service is available 6 AM to 6 PM, Pacific Time, Monday through Friday, for the duration of your warranty period.

You may also speak with a projector support specialist by dialing one of these numbers:

- U.S.: (562) 276-4394, 6 AM to 6 PM, Pacific Time, Monday through Friday.
- Canada: (905) 709-3839, 6 AM to 6 PM, Pacific Time, Monday through Friday.



Discount-Merchant.com (800) 281-8860

THE TRUSTED SOURCE FOR PROJECTOR LAMPS AND ACCESSORIES

Days and hours of support are subject to change without notice. Toll or long distance charges may apply.

Before you call for support, please have the following information ready:

- Product name (EX30, EX50, or EX70)
- Product serial number (located on the projector)
- Proof of purchase (such as a store receipt) and date of purchase
- Computer or video configuration
- Description of the problem

Purchase Supplies and Accessories

You can purchase screens and other accessories from an Epson authorized reseller. To find the nearest reseller, call 800-GO-EPSON (800-463-7766). Or you can purchase online at www.epsonstore.com (U.S. sales) or www.epson.ca (Canadian sales).



Discount-Merchant.com (800) 281-8860
THE TRUSTED SOURCE FOR PROJECTOR LAMPS AND ACCESSORIES



Discount-Merchant.com (800) 281-8860

THE TRUSTED SOURCE FOR PROJECTOR LAMPS AND ACCESSORIES

98 *Solving Problems*

A *Technical Specifications*

General

Type of display	Epson poly-silicon TFT active matrix
Resolution (native format)	EX30 800 × 600 pixels (SVGA) EX50 1024 × 768 pixels (XGA) EX70 1280 × 800 pixels (WXGA)
Color reproduction	16.8 million colors
Light output (brightness)	EX30/EX50 High mode: White light output 2200 lumens (ISO 21118 standard) Color light output 2200 lumens Low mode: White light output 1750 lumens (ISO 21118 standard) Color light output 1750 lumens EX70 High mode: White light output 2000 lumens (ISO 21118 standard) Color light output 2000 lumens Low mode: White light output 1590 lumens (ISO 21118 standard) Color light output 1590 lumens

Contrast ratio	2000:1 (with Auto Iris setting turned on in the Image menu; see page 61) EX30 460:1 (with Auto Iris setting turned off in the Image menu; see page 61) EX50 510:1 (with Auto Iris setting turned off in the Image menu; see page 61) EX70 410:1 (with Auto Iris setting turned off in the Image menu; see page 61)
Image size	EX30 (4:3 image) 23 to 350 inches (58.4 to 889 cm) EX50 (4:3 image) 30 to 300 inches (76.2 to 762 cm) EX70 (16:10 image) 27 to 270 inches (69 to 685.8 cm)
Projection distance	EX30 (4:3 image) 34 to 412 inches (87 to 1047 cm) EX50 (4:3 image) 33 to 412 inches (84 to 1047 cm) EX70 (16:10 image) 33 to 412 inches (84 to 1047 cm)
Projection methods	Front, rear, upside-down (ceiling mount)
Internal sound system (monaural)	EX30/EX50 1 W EX70 7 W
Optical aspect ratio	EX30/EX50 4:3 (horizontal:vertical) EX70 16:10 (horizontal:vertical)

Zoom ratio	EX30 Digital 1:1.35 EX50/EX70 Manual 1:1.2
Noise level	28 dB in Low Brightness mode 35 dB in High Brightness mode
Keystone correction	Manual: $\pm 30^\circ$ vertical Auto Keystone (EX50/EX70 only): 0 to 11° vertical

Projection Lamp

Type	UHE (Ultra High Efficiency)
Power consumption	170 W
Lamp life	Approx. 3000 hours (High Brightness mode) Approx. 4000 hours (Low Brightness mode)
Part number	V13H010L41

note

Lamp life results will vary depending upon mode selected, environmental conditions, and usage.

Turn off this product when not in use to prolong the life of the projector.

Remote Control

Range	19.7 feet (6 meters)
Batteries (2)	Alkaline AA

Dimensions

Height	3.6 inches (92 mm), not including feet
Width	12.9 inches (327 mm)
Depth	9.6 inches (245 mm)
Weight (without lens)	EX30 6 lb (2.7 kg) EX50 6.2 lb (2.8 kg) EX70 6.2 lb (2.8 kg)



Discount-Merchant.com (800) 281-8860

THE TRUSTED SOURCE FOR PROJECTOR LAMPS AND ACCESSORIES

Electrical

Rated frequency	50/60 Hz AC
Power supply	100 to 240 VAC \pm 10%, 2.8A to 1.5 A
Power consumption	Operating: 246 W Standby: 3 W

Environmental

Temperature	Operating: 41 to 95 °F (5 to 35 °C) Storage: 14 to 140 °F (-10 to 60 °C)
Humidity (non-condensing)	Operating: 20 to 80% RH
Operating altitude	0 to 7500 ft (0 to 2286 m); over 4921 ft (1500 m), enable High Altitude mode in the Extended menu (see page 66)

Safety and Approvals

United States	FCC 47CFR Part 15B Class B (DoC) UL60950-1 First Edition (cTUVus Mark)
Canada	ICES-003 Class B CSA C22.2 No. 60950-1



Pixelworks™ DNX™ ICs are used in this projector.

Compatible Video Formats

These projectors support the high definition video and computer display formats listed here.

To project images output from a computer, the computer's video card must be set at a refresh rate (vertical frequency) that's compatible with the projector. Some images are automatically resized using Epson's SizeWize™ technology to display in the projector's native format. The frequencies of some computers may not allow images to display correctly; see your computer's documentation for details.

EX30/EX50

Computer, component video, composite video, and S-Video

Mode	Refresh rate (Hz)	Resolution
VGA EGA	70	640 × 350
VGA—60	60	640 × 480 (640 × 360*)
VESA—72	72	640 × 480 (640 × 360*)
VESA—75	75	640 × 480 (640 × 360*)
VESA—85	85	640 × 480 (640 × 360*)
SVGA—56	56	800 × 600 (800 × 450*)
SVGA—60	60	800 × 600 (800 × 450*)
SVGA—72	72	800 × 600 (800 × 450*)
SVGA—75	75	800 × 600 (800 × 450*)
SVGA—85	85	800 × 600 (800 × 450*)
XGA—60	60	1024 × 768 (1024 × 576*)
XGA—70	70	1024 × 768 (1024 × 576*)
XGA—75	75	1024 × 768 (1024 × 576*)
XGA—85	85	1024 × 768 (1024 × 576*)
SXGA1—70	70	1152 × 864
SXGA1—75	75	1152 × 864
WXGA—60	60	1280 × 800
WXGA—75	75	1280 × 800
SXGA2—60	60	1280 × 960
SXGA3—60	60	1280 × 1024
WXGA1—60	60	1280 × 768
WXGA2—60	60	1360 × 768
WXGA160	60	1440 × 900
SXGA+60	60	1400 × 1050



FixYourDLR.com

Discount-Merchant.com (800) 281-8860

THE TRUSTED SOURCE FOR PROJECTOR LAMPS AND ACCESSORIES

Technical Specifications 103

Computer, component video, composite video, and S-Video

Mode	Refresh rate (Hz)	Resolution
iMAC VGA	117	640 × 480 (640 × 360*)
iMAC SVGA	95	800 × 600 (800 × 450*)
iMAC XGA	75	1024 × 768 (1024 × 576*)
MAC13	67	640 × 480
MAC16	75	832 × 624
MAC19	75	1024 × 768
MAC19-60	60	1024 × 768
MAC21	75	1152 × 870
NTSC	60	720 × 480 (720 × 360*)
NTSC 4:43	60	720 × 480 (720 × 360*)
PAL	50	720 × 576 (720 × 432*)
N-PAL	50	720 × 576 (720 × 432*)
M-PAL	60	720 × 576 (720 × 432*)
PAL—60	60	720 × 576 (720 × 432*)
SECAM	50	720 × 576 (720 × 432*)
SDTV (480i)	60	720 × 480 (720 × 360*)
SDTV (576i)	50	720 × 576 (720 × 432*)
SDTV (480p)	60	720 × 480 (720 × 360*)
SDTV (576p)	50	720 × 576 (720 × 432*)
HDTV (720p)	60/50	1280 × 720
HDTV (1080i)	60/50	1920 × 1080

* Letterbox signal

EX70

Computer, component video, composite video, and S-Video

Mode	Refresh rate (Hz)	Resolution
VGA EGA	70	640 × 350
VGA—60	60	640 × 480 (640 × 360*)
VESA—72	72	640 × 480 (640 × 360*)
VESA—75	75	640 × 480 (640 × 360*)
VESA—85	85	640 × 480 (640 × 360*)
SVGA—56	56	800 × 600 (800 × 450*)
SVGA—60	60	800 × 600 (800 × 450*)
SVGA—72	72	800 × 600 (800 × 450*)
SVGA—75	75	800 × 600 (800 × 450*)
SVGA—85	85	800 × 600 (800 × 450*)
XGA—60	60	1024 × 768 (1024 × 576*)
XGA—70	70	1024 × 768 (1024 × 576*)
XGA—75	75	1024 × 768 (1024 × 576*)
XGA—85	85	1024 × 768 (1024 × 576*)
SXGA1—70	70	1152 × 864
SXGA1—75	75	1152 × 864
SXGA1—85	85	1152 × 864
SXGA1—100	100	1152 × 864
WXGA—60	60	1280 × 800
WXGA—75	75	1280 × 800
WXGA—85	85	1280 × 800
SXGA2—60	60	1280 × 960
SXGA2—75	75	1280 × 960
SXGA2—85	85	1280 × 960
SXGA3—60	60	1280 × 1024
SXGA3—75	75	1280 × 1024
SXGA3—85	85	1280 × 1024
WXGA1—60	60	1280 × 768
WXGA2—60	60	1360 × 768
WXGA+60	60	1440 × 900
WXGA+75	75	1440 × 900
WXGA+85	85	1440 × 900
SXGA+60	60	1400 × 1050
SXGA+75	75	1400 × 1050
SXGA+85	85	1400 × 1050
UXGA—60	60	1600 × 1200
WSXGA+—60**	60	1680 × 1050



FixYourDLP.com

Sports

Discount-Merchant.com (800) 281-8860

THE TRUSTED SOURCE FOR PROJECTOR LAMPS AND ACCESSORIES

Technical Specifications

105

Computer, component video, composite video, and S-Video

Mode	Refresh rate (Hz)	Resolution
iMAC VGA	117	640 × 480 (640 × 360*)
iMAC SVGA	95	800 × 600 (800 × 450*)
iMAC XGA	75	1024 × 768 (1024 × 576*)
MAC13	67	640 × 480
MAC16	75	832 × 624
MAC19	75	1024 × 768
MAC19-60	60	1024 × 768
MAC21	75	1152 × 870
NTSC	60	720 × 480 (720 × 360*)
NTSC 4:43	60	720 × 480 (720 × 360*)
PAL	50	720 × 576 (720 × 432*)
N-PAL	50	720 × 576 (720 × 432*)
M-PAL	60	720 × 576 (720 × 432*)
PAL—60	60	720 × 576 (720 × 432*)
SECAM	50	720 × 576 (720 × 432*)
SDTV (480i)	60	720 × 480 (720 × 360*)
SDTV (576i)	50	720 × 576 (720 × 432*)
SDTV (480p)	60	720 × 480 (720 × 360*)
SDTV (576p)	50	720 × 576 (720 × 432*)
HDTV (720p)	60/50	1280 × 720
HDTV (1080i)	60/50	1920 × 1080

* Letterbox signal

** Available only when you select **Wide** as the Resolution setting

HDMI signals

Mode	Refresh rate (Hz)	Resolution
VGA	60	640 × 480 (640 × 360*)
SVGA	60	800 × 600
XGA	60	1024 × 768
SXGA	60	1280 × 960
SXGA	60	1280 × 1024
SXGA+	60	1400 × 1050
UXGA	60	1600 × 1200
SDTV (480i)	60	720 × 480 (720 × 360*)
SDTV (576i)	50	720 × 576 (720 × 432*)
SDTV (480p)	60	720 × 480 (720 × 360*)
SDTV (576p)	50	720 × 576 (720 × 432*)
HDTV (720p)	60/50	1280 × 720
HDTV (1080i)	60/50	1920 × 1080
HDTV (1080p)	60/50	1920 × 1080

* Letterbox signal



Discount-Merchant.com (800) 281-8860

THE TRUSTED SOURCE FOR PROJECTOR LAMPS AND ACCESSORIES

B

Notices

This appendix includes safety instructions and other important information about your projector.

Important Safety Instructions

Follow these safety instructions when setting up and using the projector:

- Do not look into the lens when the projector is on. The bright light can damage your eyes.
- Do not place the projector on an unstable cart, stand, or table.
- Do not operate the projector on its side, or while tilted to one side. Do not tilt the projector forward or back at a greater angle than that specified for keystone correction (see page 101).
- If the projector is mounted on a ceiling, it should be installed by qualified technicians using mounting hardware designed for use with this projector.
- If you use a ceiling mount and apply adhesives to the mount to prevent the screws from loosening, or if you use lubricants or oils on the projector, the projector case may crack and the projector may fall from its ceiling mount. This could cause serious injury to anyone under the mount and could damage the projector. When installing or adjusting a ceiling mount, do not use adhesives to prevent the screws from loosening and do not use oils or lubricants.
- Do not stand on the projector or place heavy objects on it.
- Do not use the projector where it may be exposed to rain, water, or excessive humidity.
- Unplug the projector from the wall outlet before cleaning. Use a dry cloth (or, for stubborn dirt or stains, a moist cloth that has been wrung dry) for cleaning. Do not use liquid or aerosol cleaners.
- Never spill liquid of any kind into the projector.
- Do not use the projector where it may be exposed to excessive dust or smoke.

- Never push objects of any kind through the cabinet slots.
- Do not use or store the projector or remote control in a hot location, such as near a heater, in direct sunlight, or in a closed vehicle.
- Do not block the slots and openings in the projector case. They provide ventilation and prevent the projector from overheating. Do not operate the projector on a sofa, rug, or other soft surface, or set it on top of loose papers, which could block vents underneath your projector. If you are setting up the projector near a wall, leave at least 7.9 inches (20 cm) of space between the wall and the air exhaust vent.
- Do not operate the projector in a closed-in cabinet unless proper ventilation is provided.
- If you are using two or more projectors side-by-side, leave at least 2 feet (60 cm) of space between the projectors to allow for proper ventilation.
- You may need to clean the air filter and vent. A clogged air filter or vent can block ventilation needed to cool the projector.
- Do not store the projector outdoors for an extended length of time.
- Do not use the projector outside the required temperature range of 41 to 95 °F (5 to 35 °C). Doing so may cause an unstable display and could lead to projector damage.
- Do not store the projector outside the required temperature range of 14 to 140 °F (-10 to 60 °C) or in direct sunlight for long periods of time. Doing so may cause damage to the case.
- Do not touch the plug during an electrical storm. Otherwise, you may receive an electric shock.
- Unplug the projector when it will not be used for extended periods.
- Unplug the projector from the wall outlet and refer servicing to qualified service personnel under the following conditions: If it does not operate normally when you follow the operating instructions, or exhibits a distinct change in performance; If smoke, strange odors, or strange noises come from the projector; If the power cord or plug is damaged or frayed; If liquid or foreign objects get inside the projector, or if it has been exposed to rain or water; If it has been dropped or the housing has been damaged.
- Except as specifically explained in this *User's Guide*, do not attempt to service this product yourself. Refer all servicing to qualified personnel. Opening or removing covers may expose you to dangerous voltages and other hazards.
- Never open any covers on the projector except as specifically explained in this *User's Guide*. Never attempt to disassemble or modify the projector. Refer all repairs to qualified service personnel.

- Use the type of power source indicated on the projector. Use of a different power source may result in fire or electric shock. If you are not sure of the power available, consult your dealer or power company.
- If you use the projector in a country other than where you purchased it, use the correct power cord for that country.
- Do not overload wall outlets, extension cords, or power strips. Do not insert the plug into a dusty outlet. This can cause fire or electric shock.
- Take the following precautions when handling the plug: Do not hold the plug with wet hands. Do not insert the plug into an outlet with dust present. Insert the plug firmly into the outlet. Do not pull the power cord when disconnecting the plug; always be sure to hold the plug when disconnecting it. Failure to comply with these precautions could result in fire or electric shock.
- Do not place the projector where the cord can be walked on.
- (Hg) The lamp(s) in this product contain mercury. Please consult your state and local regulations regarding disposal or recycling. Do not put in the trash.
- Do not place anything that can become warped or damaged by heat near the exhaust vents. Do not bring your hands or face close to the vents while projection is in progress.
- Before you move the projector, make sure its power is turned off, the plug is disconnected from the outlet, and all cables are disconnected.
- Never try to remove the lamp immediately after use because it will be extremely hot. Before removing the lamp, turn off the power and wait at least an hour to allow the lamp to cool completely.
- Do not place the source of an open flame, such as a lit candle, on or near the projector.
- Do not modify the power cord. Do not place heavy objects on top of the power cord or bend, twist, or pull it excessively. Keep the power cord away from hot electrical appliances.
- If the lamp breaks, ventilate the room to prevent gases contained in the lamp from being inhaled or coming in contact with the eyes or mouth.
- If the projector is mounted overhead and the lamp breaks, be careful to prevent pieces of glass from falling into your eyes when you open the lamp cover.

WARNING: The cords included with this product contain chemicals, including lead, known to the State of California to cause birth defects or other reproductive harm. *Wash hands after handling.* (This notice is provided in accordance with Proposition 65 in Cal. Health & Safety Code §25249.5 and following.)

FCC Compliance Statement

For United States Users

This equipment has been tested and found to comply with the limits for a Class B digital device, pursuant to Part 15 of the FCC Rules. These limits are designed to provide reasonable protection against harmful interference in a residential installation. This equipment generates, uses, and can radiate radio frequency energy and, if not installed and used in accordance with the instructions, may cause harmful interference to radio or television reception. However, there is no guarantee that interference will not occur in a particular installation. If this equipment does cause interference to radio and television reception, which can be determined by turning the equipment off and on, the user is encouraged to try to correct the interference by one or more of the following measures:

- Reorient or relocate the receiving antenna.
- Increase the separation between the equipment and receiver.
- Connect the equipment into an outlet on a circuit different from that to which the receiver is connected.
- Consult the dealer or an experienced radio/TV technician for help.

WARNING

The connection of a non-shielded equipment interface cable to this equipment will invalidate the FCC Certification of this device and may cause interference levels which exceed the limits established by the FCC for this equipment. It is the responsibility of the user to obtain and use a shielded equipment interface cable with this device. If this equipment has more than one interface connector, do not leave cables connected to unused interfaces. Changes or modifications not expressly approved by the manufacturer could void the user's authority to operate the equipment.

For Canadian Users

This Class B digital apparatus meets all requirements of the Canadian Interference-Causing Equipment Regulations.

Cet appareil numérique de la classe B respecte toutes les exigences du Règlement sur le matériel brouilleur du Canada.

Index

A

- A/V Mute
 - button, 50
 - display settings, 66, 71
- A/V Mute slide
 - closing, 50, 67, 83
 - opening, 37, 51, 89
- Accessories, 12 to 13
- Air filter
 - cleaning, 76 to 77
 - ordering, 12
 - replacing, 77
- Altitude, 67, 88, 102
- Anti-theft device, 12, 23, 72
- Aspect ratio, 47 to 48, 64, 100
- Audio
 - cable, 34
 - connecting equipment, 34
 - controlling volume, 52
 - problems, troubleshooting, 95
 - turning off (using A/V Mute), 50
- Auto Iris setting, 62
- Auto Keystone setting, 44, 65
- Auto Setup setting, 63

B

- Background screen settings, 66, 71
- Bands, vertical, 93
- Batteries, replacing, 82
- Blackboard color mode, 46
- Blurry image, 93
- Brightness, 99
- Brightness Control setting, 65, 78, 81
- Brightness setting, 62

C

- Cables
 - audio, 34
 - component-to-VGA, 12, 27, 31
 - composite, 27, 29
 - HDMI, 28
 - illustrations, 16
 - ordering, 12 to 13
 - security, 73
 - S-Video, 12, 30
 - USB, 16, 24 to 26, 34 to 35
 - VGA, 26, 32
- Capturing image, 70 to 71
- Carrying cases, 10, 13, 16, 83
- Ceiling mount, 12, 23
- Chalkboard, projecting on, 46
- Cleaning
 - air filter, 76 to 77
 - lens, 76
 - projector case, 76
- Color
 - correcting, 46, 61 to 62
 - problems, 94
 - saturation, 62
 - settings, 62
 - temperature, 62
- Color Mode, 46, 62
- Component-to-VGA video cable, 12, 27, 31
- Composite video cable, 27, 29
- Computer
 - connecting to, 24 to 26
 - selecting source, 42
- Connecting projector
 - to audio equipment, 34
 - to computer, 24 to 26
 - to digital camera, 35
 - to external monitor, 33
 - to USB device, 34 to 35
 - to video equipment, 27 to 32
- Contrast ratio, 10, 100

Contrast setting, 62
Control Panel Lock setting, 65, 72 to 73, 89
Custom screen, *see* User's Logo

D

Default settings, restoring, 61
Digital camera, connecting, 35
Dimensions, projector, 101
Direct Power On, 39
Distance from projector to screen, 18 to 19, 100
Documentation, 10 to 11
DVD player, connecting, 27 to 32

E

Electrical specifications, 102
Environmental specifications, 102
Epson
 accessories, 12 to 13
 presentation tips, 11
 PrivateLine Support, 11
 technical support, 11, 96 to 97
 warranty, 12
Error status lights, 88
Extended menu, 66 to 67
External monitor, connecting, 33
E-Zoom buttons, 51

F

FCC compliance statement, 112
Features, projector, 9 to 10
Feet, projector, 43
Filter, *see* Air filter
Fn key, notebook, 90
Focusing image, 45
Freeze button, 51
Full aspect setting, 48

G

Game color mode, 46

H

HDMI cable, 28
HDMI Video Range setting, 64
HDTV images, video formats, 107
Height of image, adjusting, 43
Help system, using, 86
Help, Epson, 11, 96 to 97
High Altitude mode, 67, 88, 102

I

Image
 adjusting, 43 to 48, 61 to 62
 blurry, 93
 capturing and saving in projector, 70 to 71
 correcting shape, 44 to 45, 65, 92
 fitting on screen, 63, 91 to 92
 height, adjusting, 43
 presentation cameras, 13
 problems with, 89 to 94
 projecting on chalkboard, 46
 raising, 43
 selecting source, 42
 shape, correcting, 44 to 45
 size and projection distance, 18 to 19, 100
 turning off (using A/V Mute), 50
 turning off temporarily, 50 to 51
 zooming, 45, 51
Image menu, 61 to 62
Info menu, 81
Input Signal setting, 26, 31, 32, 64
Input signal, selecting, 42
Installing, projector, 17 to 23
Instant Off, 40
iPod, connecting, 34 to 35

K

Kensington anti-theft device, 12, 23, 73
Keystone correction, 44 to 45, 65, 92, 101



Discount-Merchant.com (800) 281-8860

THE TRUSTED SOURCE FOR PROJECTOR LAMPS AND ACCESSORIES

L

- Lamp
 - number of hours used, 81
 - ordering, 12
 - replacing, 78 to 81
 - specifications, 101
 - status light, 78, 87 to 88
- Lamp timer, resetting, 80 to 81
- Language setting, 67
- Laptop computer
 - connecting to, 24 to 26
 - display problems, 89 to 90
 - selecting source, 42
- Lens Cover Timer setting, 51, 67
- Lens, cleaning, 76
- Light output specifications, 99
- Lights, status, 87 to 88
- Locking
 - buttons, 72
 - projector, 72
- Logo, saving on projector, 70 to 71

M

- Macintosh display problems, 91
- Manuals, 10 to 11
- Menus
 - changing settings, 60
 - default settings, restoring, 61
 - Extended, 66 to 67
 - Image, 61 to 62
 - Info, 81
 - Reset, 61, 81
 - Settings, 65
 - Signal, 63 to 64
 - User's Logo, 70 to 71
- Monitor, connecting external, 33
- Mouse, using remote control as, 53 to 54

N

- No Signal message, 90 to 91
- Noise level, 101
- Normal aspect setting, 48
- Not Supported message, 91

- Num button, 69
- Numeric keypad, using, 69

O

- Optical aspect ratio, 47 to 48, 100
- Options for projector, 12 to 13

P

- Page Up (+)/Page Down (-) buttons, 53 to 54
- Page Up/Down setting, 54, 67
- Password
 - Protect sticker, 16
 - protection, 68 to 70
 - request code, 69
- Photo color mode, 46
- Picture source, selecting, 42
- Picture, *see* Image
- Position setting, 64, 91
- Positioning
 - image, 43
 - projector, 17 to 23
- Power
 - button, 39
 - specifications, 102
 - status light, 39, 87 to 88
- PowerPoint, 23, 54, 55, 67
- Presentation color mode, 46
- Presentation tips and training, 11
- Presenters Online, 11
- PrivateLine Support, 11
- Problems
 - color, 94
 - image, 89 to 94
 - no signal, 90 to 91
 - remote control, 95
 - sound, 95
 - using on-screen help, 86
- Progressive format, 64
- Projection lamp, *see* Lamp
- Projection setting, 66



FixYourDLP.com

Sponsored by

Discount-Merchant.com (800) 281-8860

THE TRUSTED SOURCE FOR PROJECTOR LAMPS AND ACCESSORIES

Index 115

Projector
cleaning, 76
disabling buttons, 72 to 73
distance from screen, 18 to 19, 100
features, 9 to 10
installing, 17 to 23
lamp specifications, 101
options, 12 to 13
password protection, 68 to 70
positioning, 17 to 23
resolution, 99
security features, 67 to 73
specifications, 99 to 102
transporting, 83
troubleshooting, 85 to 97
turning off, 40
turning on, 37 to 39
unpacking, 16
viewing information about, 81

R

Raising image, 43
Rear-screen projection, 23, 66
Registration, 12
Remote control
A/V Mute button, 50
as wireless mouse, 53 to 54
batteries used, 101
batteries, replacing, 82
correcting color, 46, 61 to 62
E-Zoom buttons, 51
Freeze button, 51
numeric keypad, using, 69
problems, 95
range, 101
Slideshow button, 35, 36, 42
specifications, 101
troubleshooting, 95
using, 50
Replacing lamp, 78 to 81
Request code, password, 69
Resetting lamp timer, 80 to 81
Resetting menu options, 61
Resize image, 47 to 48

Resolution, 47 to 48, 91, 99
Resolution setting, 63

S

Safety
instructions, 109 to 111
specifications, 102
Saturation setting, 62
Screen
distance from projector, 18 to 19, 100
ordering, 12 to 13
startup screen, creating, 70 to 71
Screen image, *see* Image
Screen, distance from projector, 18 to 19, 100
SD card, inserting, 36 to 37
Security
cables, 73
Control Panel Lock, 72 to 73
identifying logo, 70 to 71
Kensington lock, 12, 73
password protection, 68 to 70
Settings menu, 65
Sharpness setting, 62
Signal menu, 63 to 64
Sleep mode, 40, 67, 87, 89
Slideshow
button, 35, 36, 42
options, 57 to 58
running, 55 to 57
Sound, troubleshooting, 95
Source, selecting, 42
Speaker, specifications, 100
Specifications
brightness, 99
dimensions, 101
electrical, 102
environmental, 102
general, 99
lamp, 101
remote control, 101
resolution, 99
safety, 102
speaker, 100
video formats, 103 to 107



FixYourDLP.com

Sponsored by

Discount-Merchant.com (800) 281-8860

THE TRUSTED SOURCE FOR PROJECTOR LAMPS AND ACCESSORIES

Sports color mode, 46
sRGB color mode, 46
Startup screen
 creating, 70 to 71
 settings, 71
 user's logo, *see* User's Logo
Status lights, 87 to 88
Support, *see* Technical support
S-Video cable, 12, 30
Switching picture source, 42
Sync, adjusting, 64, 93 to 94

T

Technical support, 11, 96 to 97
Tele button, 45
Temperature
 requirements, 102
 status light, 87 to 88
Temperature, color, 62
Text color mode, 46
Theatre color mode, 46
Through aspect setting, 48
Tint setting, 62
Tracking, adjusting, 64, 93 to 94
Transporting projector, 83
Troubleshooting
 blank screen, 89 to 90
 cut-off image, 91 to 92
 distorted image, 44 to 45
 image and sound problems, 89 to 95
 no signal, 90 to 91
 projector problems, 85 to 97
 remote control problems, 95
 tapered image, 44 to 45
Turning off picture (using A/V Mute), 50
Turning off projector, 40

U

Unpacking projector, 16
USB
 cable, 16, 24 to 26, 34 to 35
 connecting external device, 34 to 35
 connecting for display, 24 to 26
 selecting TypeB port usage, 53, 67
User's Logo
 creating, 70 to 71
 display settings, 71

V

VCR, connecting, 27 to 32
VGA video cable, 26, 32
Video
 cables, 12 to 13, 16, 27
 connecting video equipment, 27 to 32
 formats, supported, 103 to 107
 selecting source, 42
Video Signal setting, 64
Volume, controlling, 52, 65

W

Warning lights, 87 to 88
Warranty, 12
Wide button, 45
Windows display problems, 90
Wireless Mouse setting, 54, 67
Wireless mouse usage, 53 to 54, 67

Z

Zoom aspect setting, 48
Zoom ratio, 101
Zoom ring, 45
Zoom setting, 45
Zooming image, 45, 51

EPSON[®]
EXCEED YOUR VISION

 **FixYourDLP.com**
Sponsored by  DM

Discount-Merchant.com (800) 281-8860
THE TRUSTED SOURCE FOR PROJECTOR LAMPS AND ACCESSORIES



Disclaimer

This user manual is provided as a free service by FixYourDLP.com. FixYourDLP is in no way responsible for the content of this manual, nor do we guarantee its accuracy. FixYourDLP does not make any claim of copyright and all copyrights remain the property of their respective owners.

About FixYourDLP.com

FixYourDLP.com (<http://www.fixyourdlp.com>) is the World's #1 resource for media product news, reviews, do-it-yourself guides, and manuals.

Informational Blog: <http://www.fixyourdlp.com>

Video Guides: <http://www.fixyourdlp.com/guides>

User Forums: <http://www.fixyourdlp.com/forum>

FixYourDLP's Fight Against Counterfeit Lamps:

<http://www.fixyourdlp.com/counterfeits>

Sponsors:

RecycleYourLamp.org – Free lamp recycling services for used lamps:

<http://www.recycleyourlamp.org>

Lamp Research - The trusted 3rd party lamp research company:

<http://www.lampresearch.com>

Discount-Merchant.com – The worlds largest lamp distributor:

<http://www.discount-merchant.com>



FixYourDLP.com

Sponsored by 