



Disclaimer

This user manual is provided as a free service by FixYourDLP.com. FixYourDLP is in no way responsible for the content of this manual, nor do we guarantee its accuracy. FixYourDLP does not make any claim of copyright and all copyrights remain the property of their respective owners.

About FixYourDLP.com

FixYourDLP.com (<http://www.fixyourdlp.com>) is the World's #1 resource for media product news, reviews, do-it-yourself guides, and manuals.

Informational Blog: <http://www.fixyourdlp.com>

Video Guides: <http://www.fixyourdlp.com/guides>

User Forums: <http://www.fixyourdlp.com/forum>

FixYourDLP's Fight Against Counterfeit Lamps:

<http://www.fixyourdlp.com/counterfeits>

Sponsors:

RecycleYourLamp.org – Free lamp recycling services for used lamps:

<http://www.recycleyourlamp.org>

Lamp Research - The trusted 3rd party lamp research company:

<http://www.lampresearch.com>

Discount-Merchant.com – The worlds largest lamp distributor:

<http://www.discount-merchant.com>



FixYourDLP.com

Sponsored by 

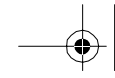

EPSON[®] PowerLite[®] 8000i/9000i

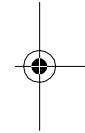
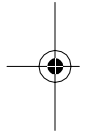

User's Guide



Discount-Merchant.com (800) 281-8860
THE TRUSTED SOURCE FOR PROJECTOR LAMPS AND ACCESSORIES

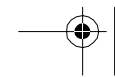
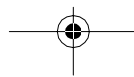

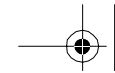

All rights reserved. No part of this publication may be reproduced, stored in a retrieval system, or transmitted in any form or by any means, electronic, mechanical, photocopying, recording, or otherwise, without the prior written permission of SEIKO EPSON CORPORATION. No patent liability is assumed with respect to the use of the information contained herein. Neither is any liability assumed for damages resulting from the use of the information contained herein.

Neither SEIKO EPSON CORPORATION nor its affiliates shall be liable to the purchaser of this product or third parties for damages, losses, costs, or expenses incurred by purchaser or third parties as a result of: accident, misuse, or abuse of this product or unauthorized modifications, repairs, or alterations to this product, or (excluding the U.S.) failure to strictly comply with SEIKO EPSON CORPORATION's operating and maintenance instructions.

SEIKO EPSON CORPORATION shall not be liable against any damages or problems arising from the use of any options or any consumable products other than those designated as Original EPSON Products or EPSON Approved Products by SEIKO EPSON CORPORATION.

EPSON and PowerLite are registered trademarks of SEIKO EPSON CORPORATION.

SoundAdvice is a service mark and FaxAdvice is a trademark of Epson America, Inc.

SRS and the  SRS[®] symbol are registered trademarks of SRS Labs, Inc., in the United States and selected foreign countries. SRS technology is incorporated under license from SRS Labs, Inc.

General Notice: Other product names used herein are for identification purposes only and may be trademarks of their respective owners. EPSON disclaims any and all rights in those marks.

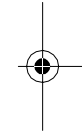
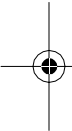

Copyright © 1999 by Epson America, Inc.
Long Beach, California, USA

CPD 9112 R1
10/99

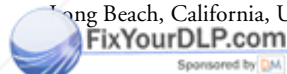

Discount-Merchant.com (800) 281-8860
ii **THE TRUSTED SOURCE FOR PROJECTOR LAMPS AND ACCESSORIES**

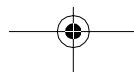



Important Information About Your Projector

Important Safety Information

WARNING: Never look into the projector lens when the lamp is turned on; the bright light can damage your eyes. Never let children look into the lens when it is on. Never open any cover on the projector, except the lamp and filter covers. Dangerous electrical voltages inside the projector can severely injure you. Except as specifically explained in this User's Guide, do not attempt to service this product yourself. Refer all servicing to qualified service personnel.

WARNING: The projector and its accessories come packaged in plastic bags. Keep plastic bags away from small children to avoid any risk of suffocation.

Caution: When you replace the lamp, never touch the new lamp with your bare hands; the invisible residue left by the oil on your hands may shorten the lamp life. Use a cloth or glove to handle the new lamp.

Remote Control Information

You can operate the projector by remote control via a line-of-sight infrared (IR) receiver at the front and rear of the projector. The projector may not respond to remote control commands under the following conditions:

- There is an object between the remote control IR emitter and the IR receiver on the projector.
- Ambient light is too bright.
- Certain types of fluorescent lighting are used.
- A strong light source shines into the IR receiver.
- Other equipment that emits infrared energy, such as a radiant room heater, is in the room.

These conditions commonly cause problems for most infrared-controlled equipment. Try the following:

- The remote control unit's batteries may be low on power; replace them.
- Dim the ambient lighting and/or turn off any fluorescent lights.
- Close any window coverings and/or move the projector out of direct sunlight.
- Turn off other equipment that emits infrared energy.

If the remote control still does not work properly, remember you can always control your computer-based presentation directly from the computer, even in an environment containing one of the conditions listed above.



Discount-Merchant.com (800) 281-8860
THE TRUSTED SOURCE FOR PROJECTOR LAMPS AND ACCESSORIES

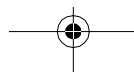



FCC Compliance Statement For United States Users

This equipment has been tested and found to comply with the limits for a Class B digital device, pursuant to Part 15 of the FCC Rules. These limits are designed to provide reasonable protection against harmful interference in a residential installation. This equipment generates, uses, and can radiate radio frequency energy and, if not installed and used in accordance with the instructions, may cause harmful interference to radio or television reception. However, there is no guarantee that interference will not occur in a particular installation. If this equipment does cause interference to radio and television reception, which can be determined by turning the equipment off and on, the user is encouraged to try to correct the interference by one or more of the following measures.

- Reorient or relocate the receiving antenna.
- Increase the separation between the equipment and receiver.
- Connect the equipment into an outlet on a circuit different from that to which the receiver is connected.
- Consult the dealer or an experienced radio/TV technician for help.

WARNING

The connection of a non-shielded equipment interface cable to this equipment will invalidate the FCC Certification of this device and may cause interference levels which exceed the limits established by the FCC for this equipment. It is the responsibility of the user to obtain and use a shielded equipment interface cable with this device. If this equipment has more than one interface connector, do not leave cables connected to unused interfaces. Changes or modifications not expressly approved by the manufacturer could void the user's authority to operate the equipment.

For Canadian Users

This Class B digital apparatus meets all requirements of the Canadian Interference-Causing Equipment Regulations.

Cet appareil numérique de la classe B respecte toutes les exigences du Règlement sur le matériel brouilleur du Canada.



Discount-Merchant.com (800) 281-8860

THE TRUSTED SOURCE FOR PROJECTOR LAMPS AND ACCESSORIES

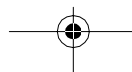

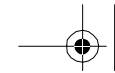

DECLARATION of CONFORMITY

According to 47CFR, Part 2 and 15

Declare under sole responsibility that the product identified herein, complies with 47CFR Part 2 and 15 of the FCC rules as a Class B digital device. Each product marketed, is identical to the representative unit tested and found to be compliant with the standards. Records maintained continue to reflect the equipment being produced can be expected to be within the variation accepted, due to quantity production and testing on a statistical basis as required by 47CFR §2.909 Operation is subject to the following two conditions: (1) this device may not cause harmful interference, and (2) this device must accept any interference received, including interference that may cause undesired operation.

Representative:	EPSON AMERICA, INC.
Address:	20770 Madrona Avenue MS: B2-11 Torrance, CA 90503
Telephone:	(310) 782-5254
Manufacturer:	SEIKO EPSON CORPORATION
Address:	3-5, Owa 3-Chome, Suwa-shi, Nagano-ken 392-8502 Japan
Type of Product:	LCD Projector
Type of Device:	Class B Personal computers and peripherals
Model:	EMP-8000/9000

We hereby declare that the equipment specified above conforms to the above Standards.



Discount-Merchant.com (800) 281-8860
THE TRUSTED SOURCE FOR PROJECTOR LAMPS AND ACCESSORIES v

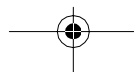
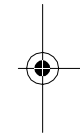

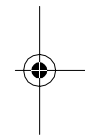
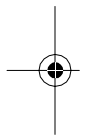
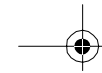

FixYourDLP.com

Sponsored by DM

Discount-Merchant.com (800) 281-8860

vi

THE TRUSTED SOURCE FOR PROJECTOR LAMPS AND ACCESSORIES

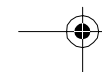
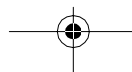



Contents

Introduction	1
Getting the Most Out of Your Projector	3
Optional Accessories	4
About This Guide	6
Where to Get Help	7
Electronic Support Services	7
Automated Telephone Services	8
Safety Instructions	9
1 Setting Up the Projector	13
Unpacking the Projector	14
Additional Components	17
Installing the Remote Control Batteries	18
Before You Connect the Projector	19



Discount-Merchant.com (800) 281-8860

THE TRUSTED SOURCE FOR PROJECTOR LAMPS AND ACCESSORIES

Connecting to a Computer	21
Connecting to a PC Desktop Computer	22
Connecting to a PC Laptop Computer	29
Connecting to a Desktop Macintosh	34
Connecting to a PowerBook	43
Connecting to a High-End Workstation	52
Connecting to a Video Source	52
Connecting to an External Speaker or PA System	56
Turning the Equipment On and Off	57
Turning the Projector On and Off	58

2 Using the Projector 61

Positioning the Projector	62
Calculating Image Size and Projection Distance	65
Focusing and Positioning the Screen Image	69
Resizing the Projected Image	71
Sleep Mode	72
Controlling the Projector	72
Using the Remote Control	73
Using the Control Panel	78
Projector Status Lights	80
Power Light	81
Projection Lamp Light	81
Temperature Light	82

3 Using the Projector Menus 83

Accessing the Main Menu	85
Changing a Menu Setting	86
Video Menu (Image Source = Computer)	88

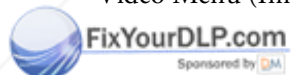

Discount-Merchant.com (800) 281-8860



Video Menu (Image Source = Video)	90
Audio Menu	92
Effect Menu	93
Setting Menu	94
User's Logo Menu	95
Capturing and Saving a Logo	95
Assigning the Logo to the A/V Mute Button	96
Reset All Menu	97
Advanced Menu	97
About Menu (Image Source = Computer)	99
About Menu (Image Source = Video)	99

4 Using ELP Link IV 101

Installing the Software	102
Connecting Needed Cables	102
Installing the Software for Windows	102
Installing the Software for a Macintosh	104
Starting ELP Link IV	105
Starting the Program from Windows	105
Starting the Program on a Macintosh	106
Changing the COM Port Assignment	106
Customizing the Remote Control Effects Buttons	107
Function Description and Usage	107
Assigning Functions	111
Setting Effects Options	112
Assigning Functions to the Keyboard	115
Saving and Recalling Effects Button Assignments	116

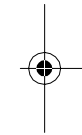

Discount-Merchant.com (800) 281-8860
THE TRUSTED SOURCE FOR PROJECTOR LAMPS AND ACCESSORIES



Controlling Projector Features117
 Using the Quick Change Toolbar117
 Changing Projector Settings118
 Changing the Test Pattern125
 Specifying an Image Gamma126
 Saving Projector Setting Files127
 Opening a Projector Setting File128
 Creating a User Logo129
 Creating Cursors/Stamps131
Exiting the Software133

5 Maintenance 135

Cleaning the Lens136
Cleaning the Projector Case136
Cleaning the Air Filter137
Replacing the Lamp138
Transporting the Projector141

6 Troubleshooting 143

Problems with the Projector144
Problems with the Remote Control147
Problems with the Image or Sound148

7 Technical Specifications 151

Glossary 159

Index 163



Discount-Merchant.com (800) 281-8860

THE TRUSTED SOURCE FOR PROJECTOR LAMPS AND ACCESSORIES

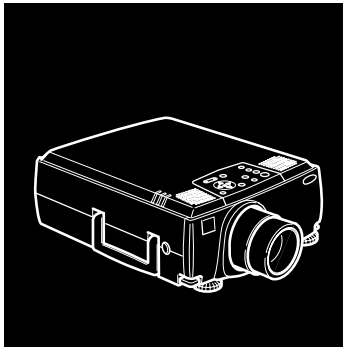

Introduction

Your EPSON® PowerLite® projector is a brilliant, lightweight, portable projector that allows you to project full-color images and video onto a large screen for presentations. You can connect it simultaneously to four image sources: two computers or workstation sources, plus two video sources, such as a VCR, DVD player, camcorder, or digital camera. You can also connect audio for each image source.

Images are displayed in full color (16,770,000 colors) at a resolution of 1024 × 768 pixels on the PowerLite 8000i and a resolution of 1366 × 1024 pixels on the PowerLite 9000i. The projector supports a wide variety of video inputs, from VGA to SXGA with resolutions up to 1600 × 1200. It produces bright images that can be easily seen in rooms light enough to take notes.



Discount-Merchant.com (800) 281-8860
THE TRUSTED SOURCE FOR PROJECTOR LAMPS AND ACCESSORIES



Your projector's two speakers employ a built-in SRS® 3D sound system for rich, powerful audio output. You can even connect an external speaker when further amplification is required.

For your presentations, you can select front, rear, or ceiling projection. This provides maximum flexibility in choosing the best display method for each environment.

You control your projector through a hand-held remote control unit, with menus provided for image source switching and image adjustment. The remote control can also act as a wireless mouse to control operations on your computer screen during presentations. Additionally, you can install the projector's ELP Link IV software to control the projector's settings from your computer and enhance your presentations with special effects.

Your projector features a new patented SizeWise™ chip for support of VGA, SVGA, XGA, SXGA and UXGA output. No matter what type of computer output is used, the result is a full-size video image of outstanding clarity.

The projector supports a wide range of computers and workstations: IBM® compatible PCs and laptops, Apple® Macintosh®, Power Macintosh,™ Power Macintosh G3,™ and PowerBook® computers, and workstations such as the Sun® SPARCstation.™ The video source can be HDTV, NTSC, PAL, or SECAM. The projector automatically senses the video format, which can be composite video, S-Video, or component video. See Chapter 7 for details on supported computers and video formats.

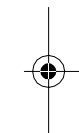

Discount-Merchant.com (800) 281-8860

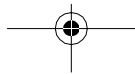



Getting the Most Out of Your Projector

Your projector comes with a full set of features that enable you to control the settings for the image display, video, and audio. To get the most out of the projector, read this section for a quick summary of the important features.

Remote Control

The buttons on the remote control allow you to turn the projector on and off, and provide direct access to zoom, freeze, volume, mute, and image source switching. Use the remote control buttons to access custom functions and the projector's menu system. You can also use the remote control to control your computer in place of your computer's mouse.

Sleep Mode

Sleep mode conserves electricity by automatically turning off the lamp after the projector has not been used for 30 minutes. In sleep mode, the projector remains on but the lamp is turned off, conserving electricity, cooling the projector, and extending the life of the lamp. To return to normal operation, press the Power button.

Online Help

Extensive online help is available for operating the projector and working in the projector's feature menus. You can display the help menu at any time by pressing the Help button on either the control panel or the remote control.



Discount-Merchant.com (800) 281-8860

THE TRUSTED SOURCE FOR PROJECTOR LAMPS AND ACCESSORIES

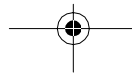

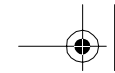

Optional Accessories

To enhance your use of the projector, EPSON provides the following optional accessories:

Product	Product number
Customized carrying cases for the projector and its cables:	
Hard shell carrying case	ELPKS22
ATA shipping case	ELPKS21
Replacement lamp and air filter	ELPLP08
Short throw zoom lens	ELPLW01
Long throw zoom lens	ELPLL02
Fixed short throw lens	ELPLR01
Communication kit cable set and computer cable so you can connect your projector to a second computer. There is also a Mac® adapter set so you can connect to a second Macintosh. You may also need the VGA-13W3 video cable if you're connecting the projector to a high-end workstation.	
ELP communication cable set	ELPKC04
Computer video cable (HD15/H15, 1.8m)	ELPKC02
Computer video cable (HD15/HD15, 3.0m)	ELPKC09
Portable projection screen	ELPSC06



FixYourDLP.com

Sponsored by

Discount-Merchant.com (800) 281-8860

4 Introduction

THE TRUSTED SOURCE FOR PROJECTOR LAMPS AND ACCESSORIES

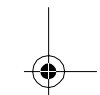
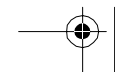
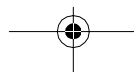
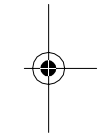

Product	Product number
Remote IR receiver	ELPST02
Mediaphile™ PAS (personal audio system)	ELPPAS1
Mediaphile CVS (clear voice system, wireless microphone and satellite speakers)	ELPCVS1

You can purchase these accessories from your dealer or by calling EPSON Accessories at **(800) 873-7766**; or visit our web site at www.epsonsupplies.com (U.S. sales only). In Canada, please call (800) 873-7766 for dealer referral.



Discount-Merchant.com (800) 281-8860
Optional Accessories 5
THE TRUSTED SOURCE FOR PROJECTOR LAMPS AND ACCESSORIES



About This Guide

This guide describes how to set up and use your EPSON PowerLite projector. The instructions apply to both the PowerLite 8000i and the PowerLite 9000i, except where noted otherwise.

Chapter 1, “Setting Up the Projector,” provides step-by-step instructions on how to set up your projector; connect it to your computer, video source, or other optional equipment; and turn it on.

Chapter 2, “Using the Projector,” explains how to position the projector relative to the screen, focus and position the screen image, control the projector using the remote control and the control panel, and monitor the projector’s operating status.

Chapter 3, “Using the Projector Menus,” describes how to use the projector’s built-in menus to adjust the color and image settings, change the display of the projected image, set and adjust various projector options, and modify audio settings such as bass and treble.

Chapter 4, “Using ELP Link IV,” explains how to use the ELP Link IV software to control the projector settings from the computer and use the special effects functions.

Chapter 5, “Maintenance,” covers basic procedures for maintaining your projector in good working order and gives guidelines for transporting it.

Chapter 6, “Troubleshooting,” describes how to interpret your projector’s warning lights and gives helpful information for avoiding errors, optimizing image quality, and solving problems.

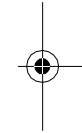
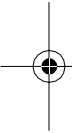

FixYourDLP.com

Sponsored by



Discount-Merchant.com (800) 281-8860

6

Introduction

THE TRUSTED SOURCE FOR PROJECTOR LAMPS AND ACCESSORIES

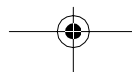

Chapter 7, "Technical Specifications," lists the technical specifications for the projector.

A Glossary and Index are provided at the end of the manual.

Where to Get Help

If you are having trouble setting up or running your projector, first see Chapter 6, "Troubleshooting." If you cannot resolve the problem, EPSON provides technical assistance through electronic support services and automated telephone services 24 hours a day. The following tables list the contact information.

Electronic Support Services

Service	Access
World Wide Web	From the Internet, you can reach EPSON's Home Page at http://www.epson.com .
EPSON Internet FTP Site	If you have Internet FTP capability, use your Web browser (or other software for FTP downloading) to log onto ftp.epson.com with the user name anonymous and your e-mail address as the password.
EPSON Forum on CompuServe®	Members of CompuServe can type GO EPSON at the menu prompt to reach the Epson America Forum. For a free introductory CompuServe membership, call (800) 848-8199 and ask for representative #529.



Discount-Merchant.com (800) 281-8860
THE TRUSTED SOURCE FOR PROJECTOR LAMPS AND ACCESSORIES



Automated Telephone Services

Service	Access
EPSON SoundAdvice SM	For pre-recorded answers to commonly asked questions about EPSON products 24 hours a day, seven days a week, call (800) 922-8911 .
EPSON FaxAdvice TM	Access EPSON's technical information library by calling (800) 922-8911 . You must provide a return fax number to use this service.
EPSON Referral Service	For the location of your nearest Authorized EPSON Reseller or Customer Care Center, call (800) 922-8911 .



When you need support, follow the calling instructions on the back of the EPSON Private Line Technical Support card included with the projector. Technical support is also available by calling (562) 276-4394 between 6 AM and 6 PM, Pacific Time, Monday through Friday. Toll or long distance charges may apply.

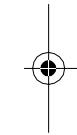

Before you call, please have the following information ready:

- Product name
- Product serial number
- Personal identification number (PIN) for EPSON Private Line Technical Support
- Computer configuration
- Description of the problem



Discount-Merchant.com (800) 281-8860

8 Introduction

THE TRUSTED SOURCE FOR PROJECTOR LAMPS AND ACCESSORIES

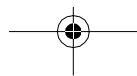



You can purchase accessories from EPSON Accessories at (800) 873-7766, or visit our web site at www.epsonsupplies.com (U.S. sales only). In Canada, please call (800) 873-7766 for dealer referral.

Safety Instructions

Follow these safety instructions when setting up and using the projector:

1. Do not place the projector on an unstable cart, stand, or table.
2. Do not use the projector near water or sources of heat.
3. Use attachments only as recommended.
4. Use the type of power source indicated on the projector. If you are not sure of the power available, consult your dealer or power company.
5. Place the projector near a wall outlet where the plug can be easily unplugged.

Placez le projecteur près d'une prise de contact où la fiche peut être débranchée facilement.

6. Insert the projector's three-wire grounding-type plug into a properly grounded outlet. If you have a two-prong outlet, contact an electrician to replace it. Do not hold the plug with wet hands.
7. Take the following precautions for the plug. Failure to comply with these precautions could result in sparks or fire.

- Do not insert the plug into an outlet with dust present.
- Insert the plug firmly into the outlet.



Discount-Merchant.com (800) 281-8860
THE TRUSTED SOURCE FOR PROJECTOR LAMPS AND ACCESSORIES

Safety Instructions

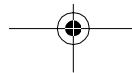
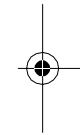



8. Do not overload wall outlets, extension cords, or integral convenience receptacles. This can cause fire or electric shock.
9. Do not place the projector where the cord can be walked on. This may result in fraying or damage to the plug.
10. Unplug the projector from the wall outlet before cleaning. Use a damp cloth for cleaning. Do not use liquid or aerosol cleaners.
11. Do not block the slots and openings in the projector case. They provide ventilation and prevent the projector from overheating. Do not operate the projector on a sofa, rug, or other soft surface, or in a closed-in cabinet unless proper ventilation is provided.
12. Never push objects of any kind through cabinet slots. Never spill liquid of any kind into the projector.
13. Except as specifically explained in this *User's Guide*, do not attempt to service this product yourself. Refer all servicing to qualified service personnel. Opening or removing covers may expose you to dangerous voltages and other hazards.
14. Unplug the projector during lightning storms or when it will not be used for extended periods.
15. Do not place the projector and remote control on top of heat-producing equipment or in a heated place, such as a car.
16. Unplug the projector from the wall outlet and refer servicing to qualified service personnel under the following conditions:
 - When the power cord or plug is damaged or frayed
 - If liquid has been spilled into the projector, or if it has been exposed to rain or water

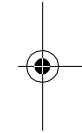
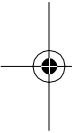

Discount-Merchant.com (800) 281-8860

10 Introduction

THE TRUSTED SOURCE FOR PROJECTOR LAMPS AND ACCESSORIES

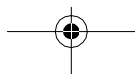



- If it does not operate normally when you follow the operating instructions, or if it exhibits a distinct change in performance, indicating a need for service
 - If it has been dropped or the housing has been damaged.
17. If you use the projector in a country other than where you purchased it, use the power cable that is suitable to that country.

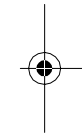

Discount-Merchant.com (800) 281-8860

THE TRUSTED SOURCE FOR PROJECTOR LAMPS AND ACCESSORIES

Safety Instructions

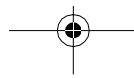

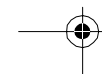
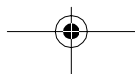
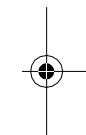
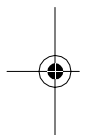
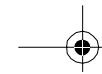

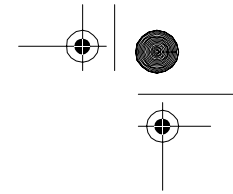
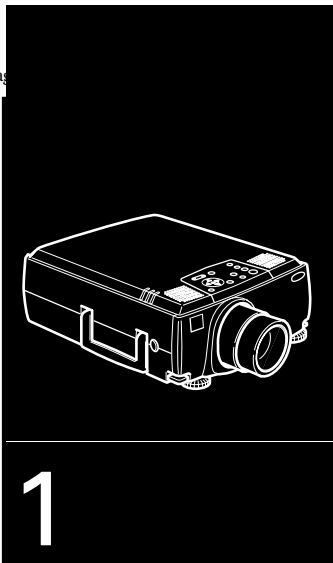
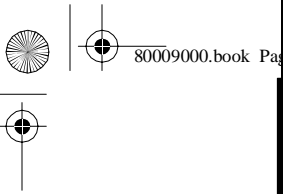

Setting Up the Projector

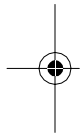

This chapter describes how to unpack your projector, connect it to other equipment, and turn everything on. The projector must be connected to a computer or a video source such as a VCR, DVD player, camcorder, digital camera, or laser disc player before it can project any images. You may also want to set up the projector for one or more of the following:

- Connect the mouse cable to use the remote control as a wireless mouse. Except for some laptops, this disables your computer's mouse. If you are also viewing the display on your monitor, you use the remote control's pointer to control the screen cursor.
- Provide audio for one or both image sources. The audio source can be the computer, video source, or another device such as a stereo.
- Connect to an external speaker or PA system to amplify the audio.

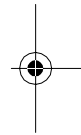

Discount-Merchant.com (800) 281-8860
THE TRUSTED SOURCE FOR PROJECTOR LAMPS AND ACCESSORIES

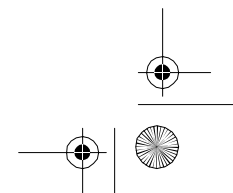
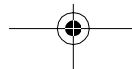
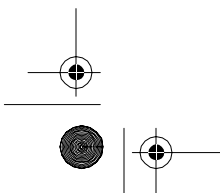

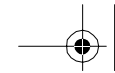

Unpacking the Projector

When you unpack the projector, make sure you have all these components:

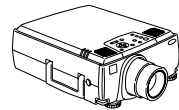

Projector

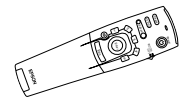

Remote control



2 AA batteries

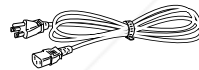

Power cord



Projector video cable



Audio cable



RCA audio cable



Discount-Merchant.com (800) 281-8860

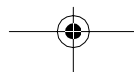



RCA video cable

Macintosh adapter set:

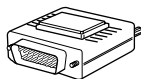

Macintosh desktop adapter

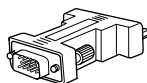

Macintosh monitor adapter

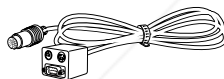

Main cable (for connecting a mouse cable to use the remote as a wireless mouse and/or a serial cable to use the ELP Link IV software)

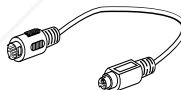

PS/2[®] mouse cable (for the PC)

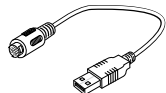

USB cable

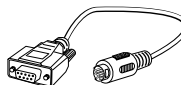

Serial mouse cable (for the PC)



Discount-Merchant.com (800) 281-8860

THE TRUSTED SOURCE FOR PROJECTOR LAMPS AND ACCESSORIES

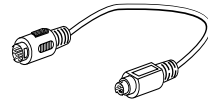

Mac mouse cable (for the Macintosh)

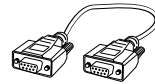

PC serial cable

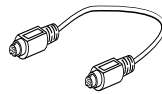

Macintosh serial cable



Projector Software CD ROM

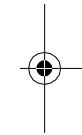

You will not need all these components; your configuration will determine which ones you need.

Save all packaging in case you need to ship the projector in the future. Always transport the projector in its original packaging (or the equivalent), or use a carrying case if you are carrying the projector by hand. (See page 141 for transporting instructions.)



Discount-Merchant.com (800) 281-8860

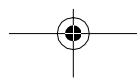



Additional Components

Depending on how you plan to use the projector, you may need additional components:

- ❑ To receive an S-Video signal, you need an S-Video cable. (One is usually provided with your video device.) A separate cable is required for each video source.
- ❑ To connect a second computer, you need a computer video and audio cable.
- ❑ To connect the projector to a Macintosh PowerBook, you may need a video-out cable (provided by Apple). If your PowerBook requires a video-out cable and you do not have one, see your Macintosh dealer.

Note: You cannot currently use the ELP Link IV software with a Power Macintosh G3 or iMac. Check with your dealer for future support.

- ❑ To connect the projector to an external sound system, you need an RCA-to-3.5 mm stereo audio cable. You can obtain one from your computer dealer.
- ❑ To connect the mouse cable to your computer, you may require a special connector, cable, or other components. You can obtain these items from your computer dealer.

Note: You can connect a Kensington MicroSaver® anti-theft device in the hole on the projector's right side. Contact your computer dealer.

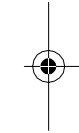

Discount-Merchant.com (800) 281-8860

THE TRUSTED SOURCE FOR PROJECTOR LAMPS AND ACCESSORIES

Unpacking the Projector

17

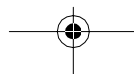

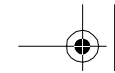

Installing the Remote Control Batteries

You can use the remote control as a wireless mouse instead of your computer's mouse to control your presentation. You can also use it to control the projector menus and use the Effects buttons.

Follow these steps to install the batteries in the remote control:

1. Slide off the battery compartment cover.

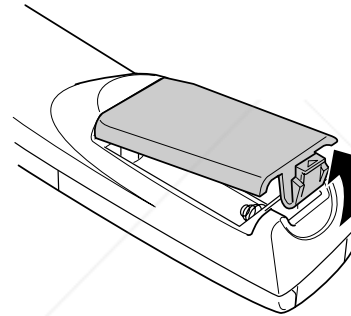

2. Insert the two AA batteries included with the projector. Make sure the polarity of the batteries is correct.

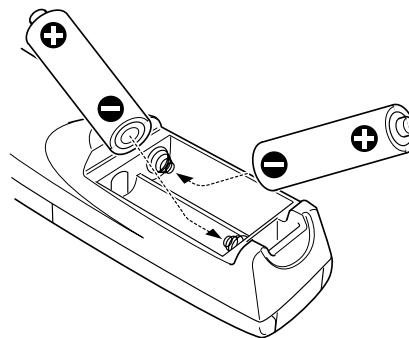

Discount-Merchant.com (800) 281-8860

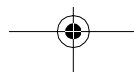

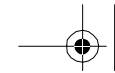

3. Replace the battery compartment cover.

When replacing batteries, take the following precautions:

- Do not mix old and new batteries.
- Replace batteries as soon as they run out. If the batteries leak, wipe away battery fluid with a soft cloth. If fluid gets on your hands, wash them immediately.
- Remove batteries if you will not be using the projector for a long period of time.

Before You Connect the Projector

Before you start connecting the projector to your equipment, decide where you will want to place your projector and computer or video source. The distance between the projector and the screen determines the actual image size. Place the projector somewhere between 3.6 and 52.1 feet (1.1 and 15.9 meters) away from the screen; use the general guidelines in the table below to determine the proper distance. (For more precise calculations, see “Positioning the Projector” on page 62.)

Caution: Do not hold or lift the projector by the lens. This can damage the lens.

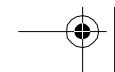
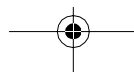
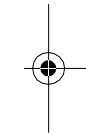
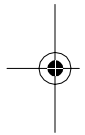
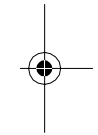

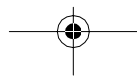

Image size (diagonal)	Horizontal distance from projector to screen	
	Minimum	Maximum
300 inches (10 m)	460.6 inches (11.7 m)	586.6 inches (14.9 m)
200 inches (5.1 m)	307.1 inches (7.8 m)	389.8 inches (9.9 m)
100 inches (2.54 m)	153.5 inches (3.9 m)	192.9 inches (4.9 m)
80 inches (2.03 m)	122.0 inches (3.1 m)	153.5 inches (3.9 m)
60 inches (1.52 m)	90.6 inches (2.3 m)	114.2 inches (2.9 m)
40 inches (1.02 m)	59.1 inches (1.5 m)	74.8 inches (1.9 m)
30 inches (0.76 m)	43.3 inches (1.1 m)	55.1 inches (1.4 m)

Be sure to place the projector on a sturdy, level surface within five feet of the computer or video source.



Discount-Merchant.com (800) 281-8860





Connecting to a Computer

You can connect the projector to any computer capable of producing standard VGA, Super VGA (SVGA), XGA, Super XGA (SXGA), or UXGA output, such as:

- ❑ IBM compatible desktop PCs
- ❑ IBM compatible laptop PCs
- ❑ Apple Macintosh desktop computers, including Macintosh Quadra[®], Macintosh Centris[®], Power Macintosh, and Power Macintosh G3
- ❑ Any Apple PowerBook with video-out capability
- ❑ Most high-end workstations from Sun, Silicon Graphics[®], IBM, and Hewlett-Packard[®] (You may need an adapter cable to connect to some high-end workstations; see page 52.)

See the section that applies to your computer. Make sure both the computer and projector are turned off before you start.

When you have finished connecting all your components, go to page 57 to turn on the projector and equipment.

The following illustration identifies all the interface ports on the back of the projector; you may want to refer to this as you connect your computer or other equipment to the projector.

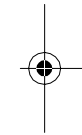

Discount-Merchant.com (800) 281-8860

THE TRUSTED SOURCE FOR PROJECTOR LAMPS AND ACCESSORIES

Connecting to a Computer

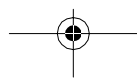

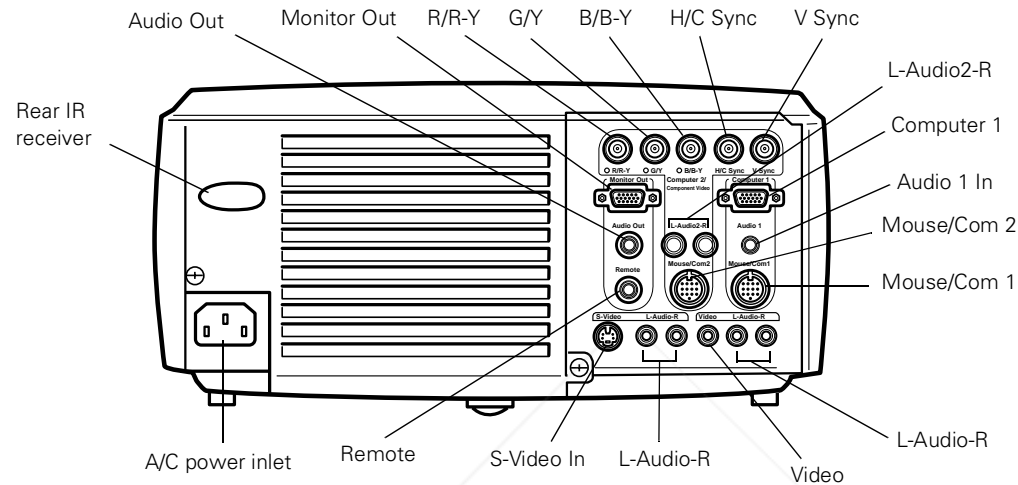

Connecting to a PC Desktop Computer

To connect the projector to your PC desktop computer, you need to:

- Connect the projector video cable and computer monitor cable
- Connect the mouse and/or serial cable (if you want to use the remote control as a mouse or use the ELP Link IV software)
- Connect the audio cable (if you'll be projecting with audio)

Follow the steps in each section for the cables you need to connect. Before beginning, turn off the projector and computer if they are on.

Note: Computer configurations vary. See your computer manual for the location of the ports needed to connect your projector.



Discount-Merchant.com (800) 281-8860

Connecting the Video and Monitor Cables

First connect the projector video cable and computer monitor cable. Refer to this illustration while following the steps below.

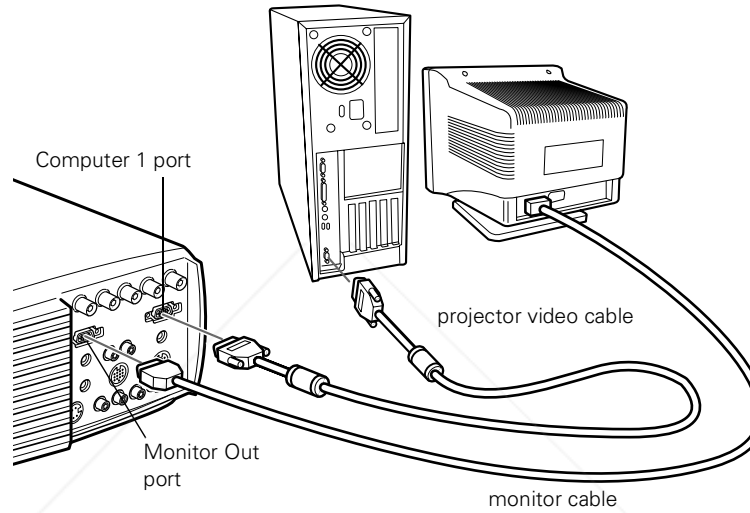



1. If you will be viewing the video on your computer monitor as well as the projector screen, disconnect the monitor cable from the video port on the back of your computer. Then connect the monitor cable to the projector's Monitor Out port, as shown below. (This is useful when you need to view the video output but the projection screen is behind you.)

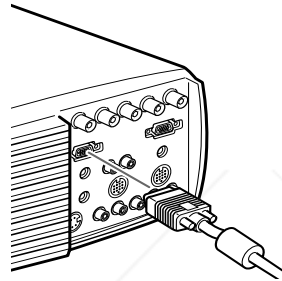

2. Connect one end of the projector video cable to the projector's Computer 1 port. (Use the Computer 2 port if you are connecting a second computer.)

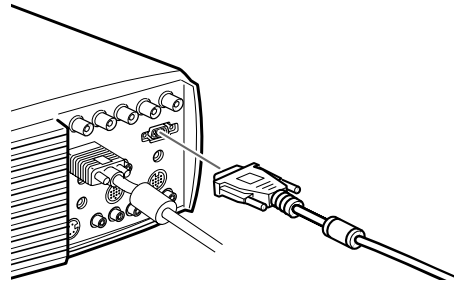

3. Connect the other end of the projector video cable to the computer's video port.



Discount-Merchant.com (800) 281-8860

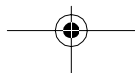

4. Tighten the screws on all connectors.

Connecting the Mouse and Serial Cables

If you want to use the remote control as a mouse or use the ELP Link IV software, you need to connect the main cable. It provides connectors for:

- ❑ The PS/2 mouse or USB cable (to use the remote control as a mouse)
- ❑ The serial cable (to use the ELP Link IV software)

Refer to this illustration while following the steps below.

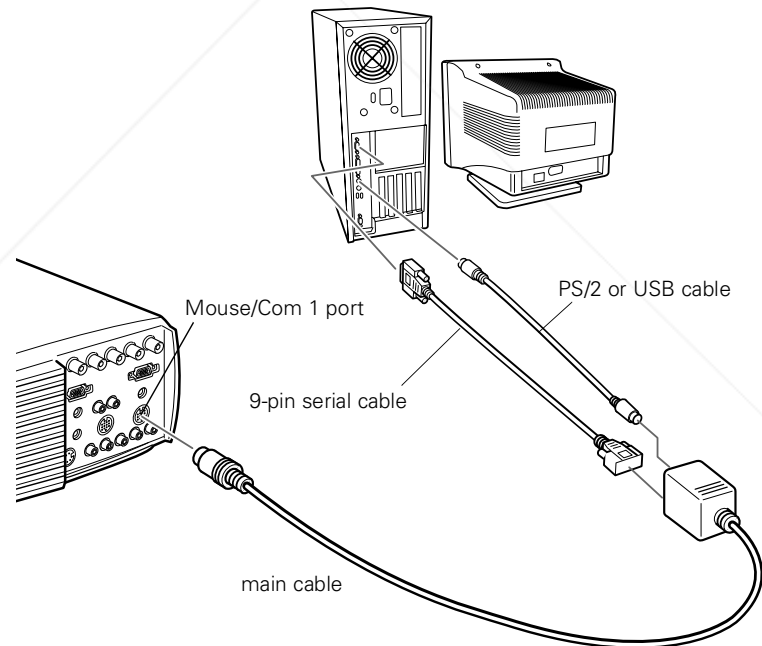

1. Connect the round end of the main cable to the projector's Mouse/Com 1 port. (Use the Mouse/Com 2 port if you are connecting a second computer.)

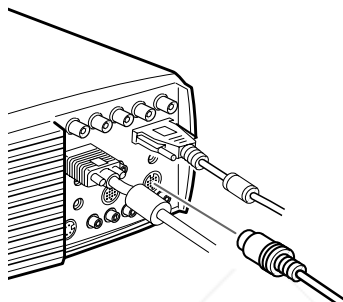

2. To use the remote control as a wireless mouse, connect the PS/2 mouse or USB cable included with the projector to the MOUSE terminal on the square end of the main cable.

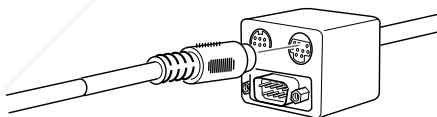

3. Disconnect your mouse from the mouse port on the back of your computer and replace it with the other end of the PS/2 mouse or USB cable. (Your computer's mouse will be disabled while you are using the remote control as a mouse.)

Note: If your system uses a serial mouse, perform steps 2 and 3 using the PC mouse serial cable instead of the PS/2 mouse or USB cable (not shown in the illustration).



Discount-Merchant.com (800) 281-8860

- To use the ELP Link IV software or to program new effects for the Effects buttons on the remote control, connect one end of the serial cable to the SERIAL terminal on the square end of the main cable.

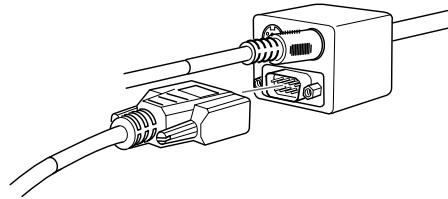

Connect the other end of the serial cable to the serial port on the back of your computer.

Note: You will not be able to use ELP Link IV if your system has only one serial port that is being used to support a serial mouse.

- Tighten the screws on all connectors.

Connecting the Audio Cable

1. If you will be using audio, connect one end of the audio cable to the Audio 1 port on the projector. (Use the Audio 2 ports if you are connecting a second computer.)

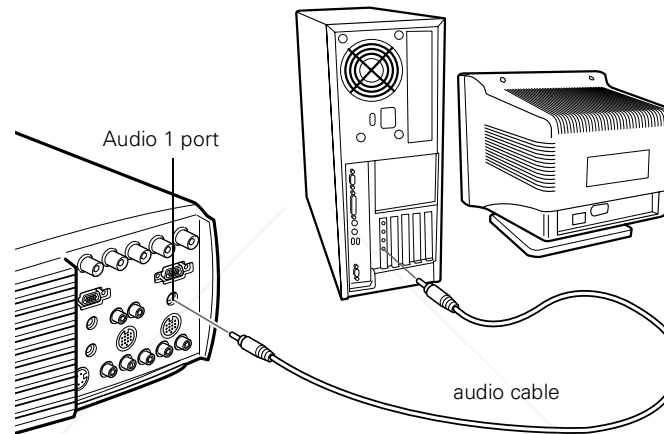

2. Connect the other end of the audio cable to the speaker or audio out port on the computer's sound card.

Connecting to a PC Laptop Computer

To connect the projector to your PC laptop computer, you need to:

- Connect the projector video cable
- Connect the mouse and/or serial cable (if you want to use the remote control as a mouse or use the ELP Link IV software)
- Connect the audio cable (if you'll be projecting with audio)

Follow the steps in each section for the cables you need to connect. Before beginning, turn off the projector and computer if they are on.

Note: Laptop configurations vary. See your computer manual for the location of the ports needed to connect your projector.

Connecting the Video Cable

First connect the projector's video cable to your laptop.

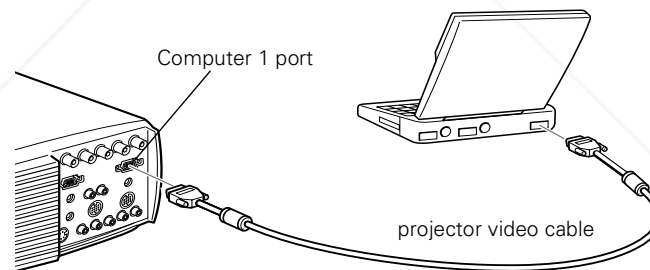

1. Connect one end of the projector video cable to the projector's Computer 1 port. (Use the Computer 2 port if you are connecting a second computer.)

2. Connect the other end of the video cable to the laptop's video (monitor) port.
3. Tighten the screws on all connectors.

Connecting the Mouse and Serial Cables

If you want to use the remote control as a mouse or use the ELP Link IV software, you need to connect the main cable. It provides connectors for:

- The PS/2 or USB cable (to use the remote control as a mouse)
- The serial cable (to use the ELP Link IV software)

Refer to this illustration while following the steps below.

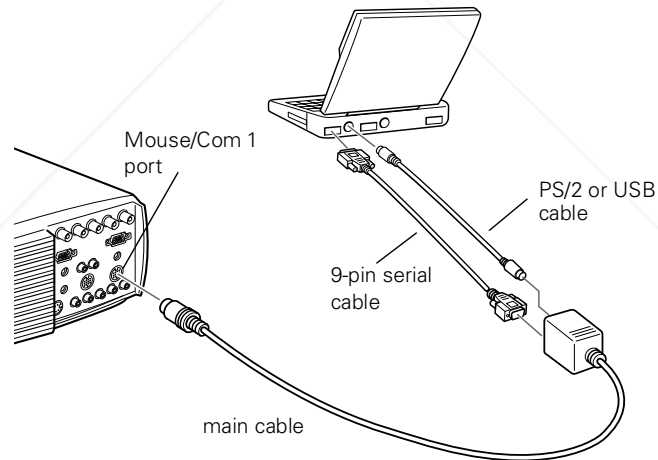

1. Connect the round end of the main cable to the projector's Mouse/Com 1 port. (Use the Mouse/Com 2 port if you are connecting a second computer.)

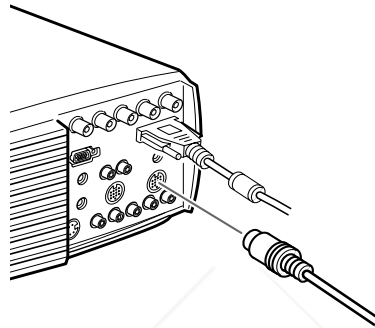

2. To use the remote control as a wireless mouse, connect the PS/2 or USB cable included with the projector to the MOUSE terminal on the square end of the main cable.

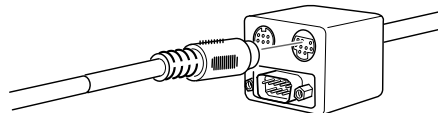

3. Connect the 6-pin (mini-DIN) end of the PS/2 mouse cable to the external mouse port or connect the USB cable to the USB port on your laptop.

Note: If your laptop uses a serial mouse, perform steps 2 and 3 using the PC serial mouse cable instead of the PS/2 or USB cable (not shown in the illustration).





- To use the ELP Link IV software, or to program new effects for the Effects buttons on the remote control, connect one end of the serial cable to the SERIAL terminal on the square end of the main cable.

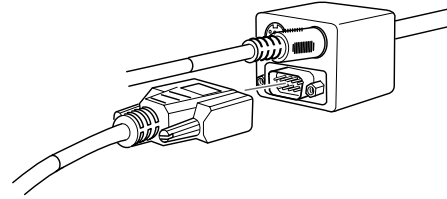

- Connect the other end of the serial cable to the serial port on the back of your computer.

Note: You will not be able to use ELP Link IV if your laptop has only one serial port that is being used to support a serial mouse.

- Configure your laptop to work with an external mouse.

Note: You may have to set the display to appear on both the laptop's screen and the projector. Some laptops let you change this setting with the keyboard's function keys or by using a setup utility provided by the computer manufacturer. Check your laptop's manual or online help for instructions.

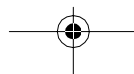
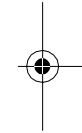
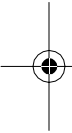

Connecting the Audio Cable

1. If you will be using audio, connect one end of the audio cable to the Audio 1 port on the projector. (Use the Audio 2 ports if you are connecting a second computer.)

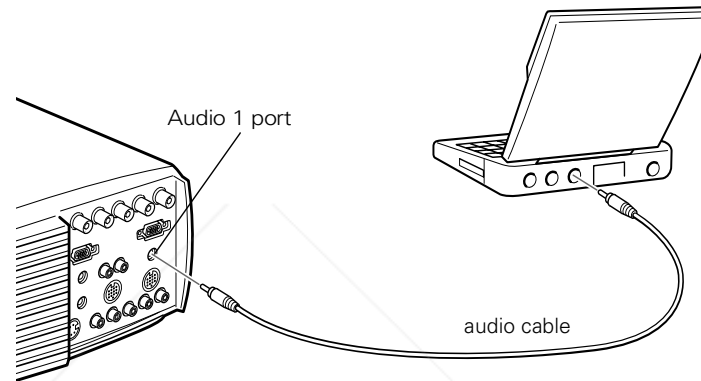

2. Connect the other end of the audio cable to your laptop.

Note: PC audio cable port locations vary. See your computer manual for the location of the audio port needed to connect your projector.



Connecting to a Desktop Macintosh

To connect the projector to your desktop Macintosh, you need to:

- Connect the projector video cable and computer monitor cable
- Connect the mouse and/or serial cable (if you want to use the remote control as a mouse or use the ELP Link IV software)
- Connect the audio cable (if you'll be projecting with audio)

Follow the steps in each section for the cables you need to connect. Before beginning, turn off the projector and computer if they are on.

Notes:

- Macintosh configurations vary. See your computer manual for the location of the ports needed to connect your projector.*
- You cannot currently use the ELP Link IV software with a Power Macintosh G3 or iMac. Check with your dealer for future support.*

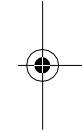
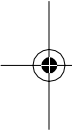

Discount-Merchant.com (800) 281-8860

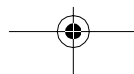

Connecting the Video and Monitor Cables

First connect the video and monitor cables. Refer to this illustration as you follow the steps below.

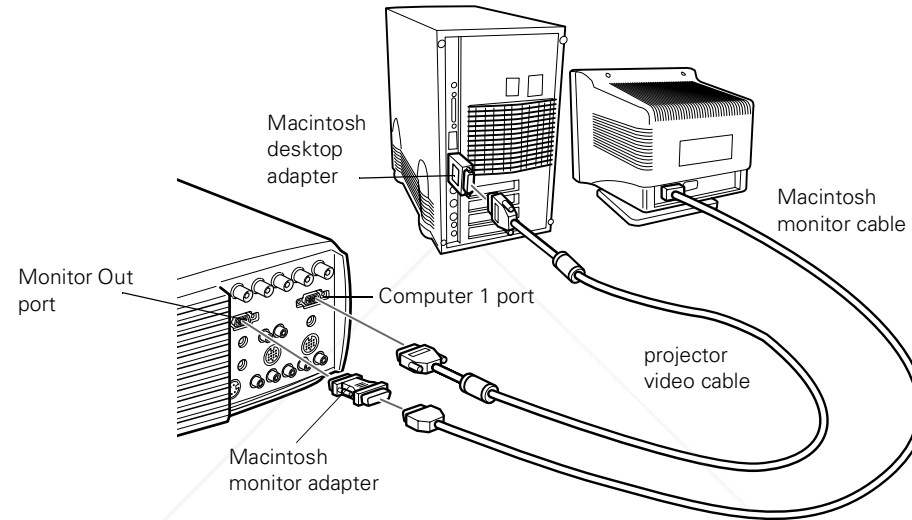

1. Connect one end of the projector video cable to the projector's Computer 1 port. (Use the Computer 2 port if you are connecting a second computer.)

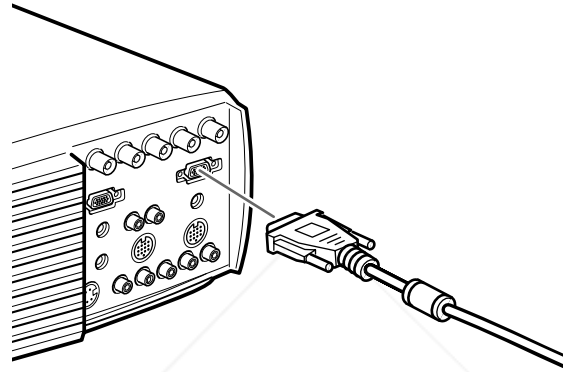

2. Remove the small cover on the Macintosh desktop adapter (as shown below) and set its DIP switches in accordance with the resolution you want to use, such as 16-inch mode. See your Macintosh documentation for instructions.

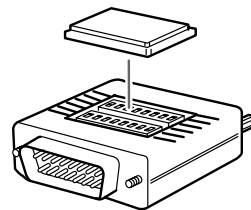

3. Connect the small terminal of the Macintosh desktop adapter to the other end of the projector video cable.

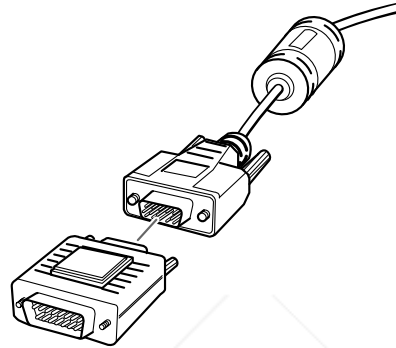

4. Disconnect the monitor cable from the video port on the back of the Macintosh. Then connect the projector video cable (with the Macintosh desktop adapter attached) to the video port on the Macintosh.

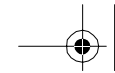

5. To also view the video on the computer's monitor, attach the large end of the Macintosh monitor adapter to the monitor cable and connect the other end of the adapter to the projector's Monitor Out port.

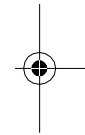
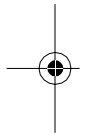
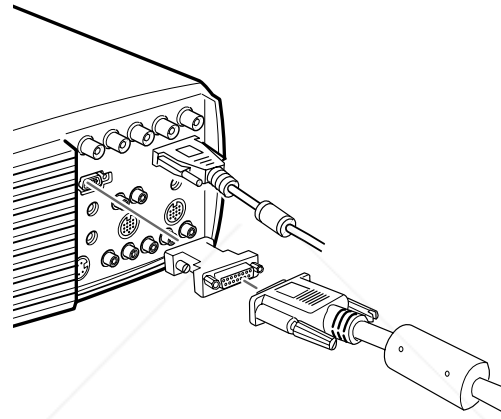

6. Tighten the screws on all the connectors.



Discount-Merchant.com (800) 281-8860

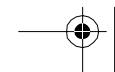
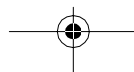

Connecting the Mouse and Serial Cables

If you want to use the remote control as a mouse or use the ELP Link IV software, you need to connect the main cable. It provides connectors for:

- The Mac mouse or USB cable (to use the remote control as a mouse)
- The Mac serial cable (to use the ELP Link IV software)

Refer to this illustration while following the steps below.

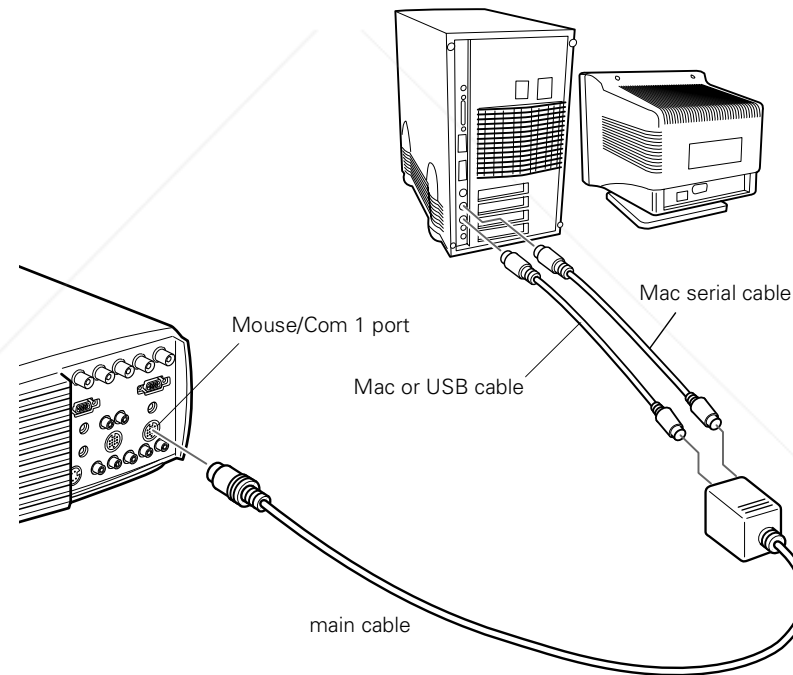

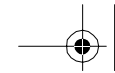

1. Connect the small end of the main cable to the projector's Mouse/Com 1 port. (Use the Mouse/Com 2 port to connect a second computer.)

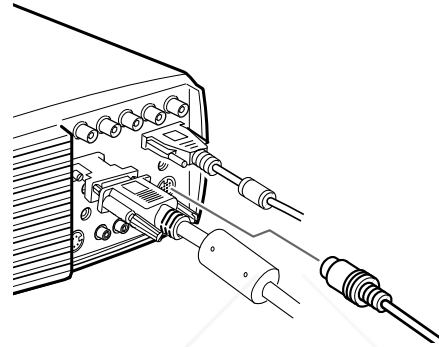

2. To use the remote control as a wireless mouse, connect one end of the projector's Mac mouse or USB cable to the MOUSE terminal on the large end of the main cable.

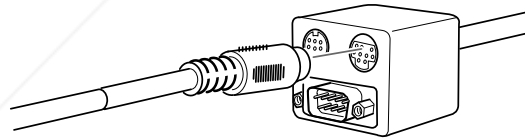

3. Disconnect your Macintosh's mouse cable. Connect the other end of the projector's Mac mouse or USB cable to the mouse or USB port on your Macintosh.



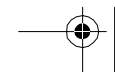
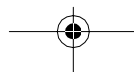

Discount-Merchant.com (800) 281-8860

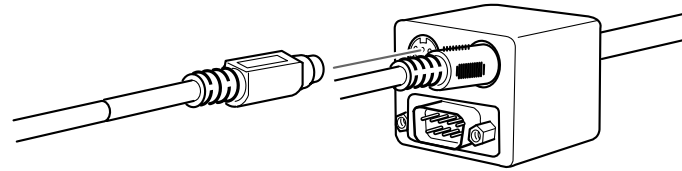

4. To use the ELP Link IV software or to program new effects for the Effects buttons on the remote control, connect one end of the Mac serial cable to the MAC SERIAL terminal on the large end of the main cable.



5. Connect the other end of the Mac serial cable to the  printer or  modem port on the back of your Macintosh.



Connecting the Audio Cable

1. If you will be using audio, connect one end of the audio cable to the Audio 1 port on the projector. (Use the Audio 2 port if you are connecting a second computer.)

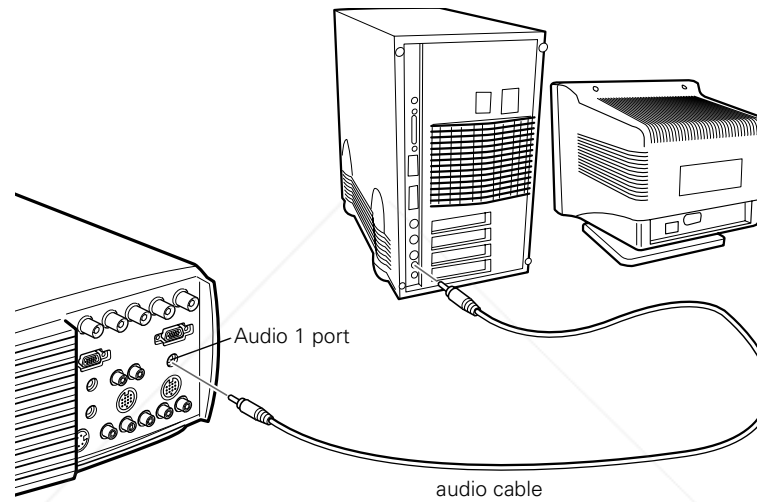

2. Connect the other end of the audio cable to the audio-out port on your computer.

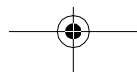

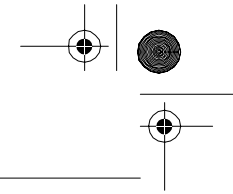

Connecting to a PowerBook

Your PowerBook must have video-out capability in order to connect to the projector.

To connect the projector to your PowerBook, you need to:

- Connect the projector video cable
- Connect the mouse and/or serial cable (if you want to use the remote control as a mouse or use the ELP Link IV software)
- Connect the audio cable (if you'll be projecting with audio)

Follow the steps in each section for the cables you need to connect. Before beginning, turn off the projector and computer if they are on.

Note: PowerBook configurations vary, so the location of your computer's ports may not match the illustrations. See your PowerBook manual for the port locations if necessary.

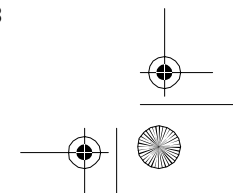
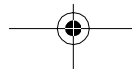
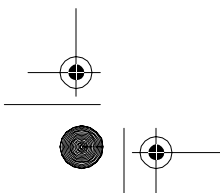
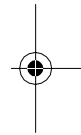
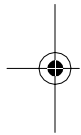

Connecting the Video Cable

First connect the projector video cable. Refer to this illustration as you follow the steps below.

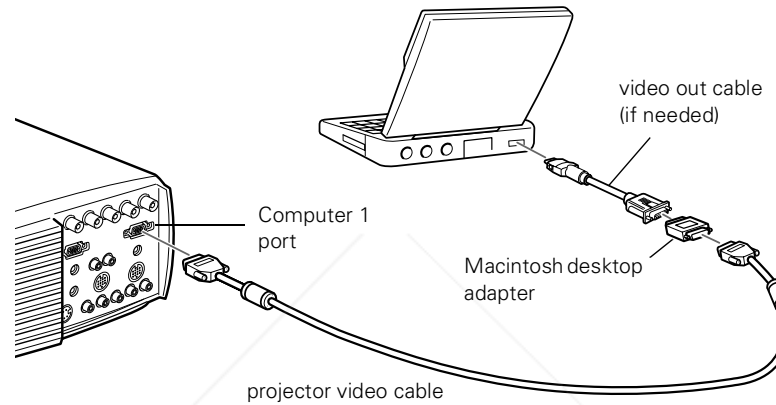

Note: Some new PowerBooks may allow you to connect the video cable directly to the computer without using a video-out cable. See your PowerBook manual for additional information on connecting a video cable.

1. Connect one end of the projector video cable to the projector's Computer 1 port. (Use the Computer 2 port if you are connecting a second computer.)

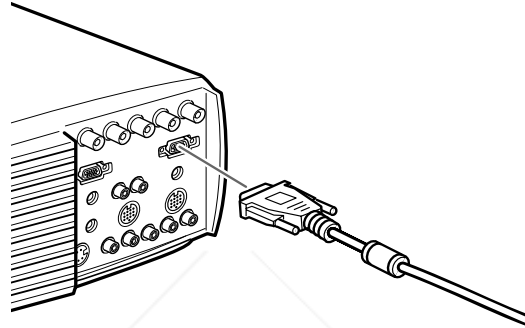

2. Remove the small cover on the Macintosh desktop adapter and set its DIP switches in accordance with the resolution you want to use (such as 16-inch mode). See your Macintosh documentation for instructions.

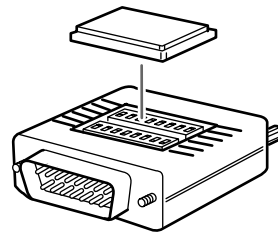

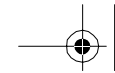

3. Connect the small terminal of the Macintosh desktop adapter to the other end of the video cable.

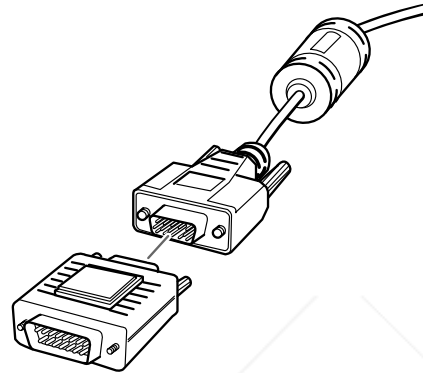

4. Connect the projector video cable (with the Macintosh desktop adapter attached) to the video-out port on the PowerBook.

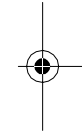
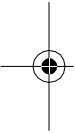

Discount-Merchant.com (800) 281-8860

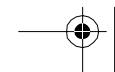
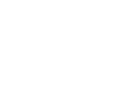
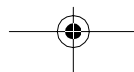

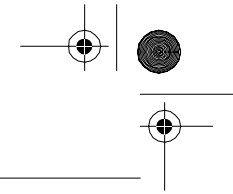

If a video-out cable was provided with your PowerBook, connect the smaller end of the video-out cable to the video-out port on the back of the PowerBook. Connect the other end to the Macintosh desktop adapter on the end of the projector video cable.

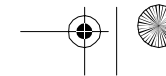
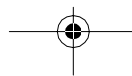
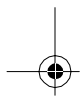
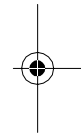
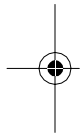
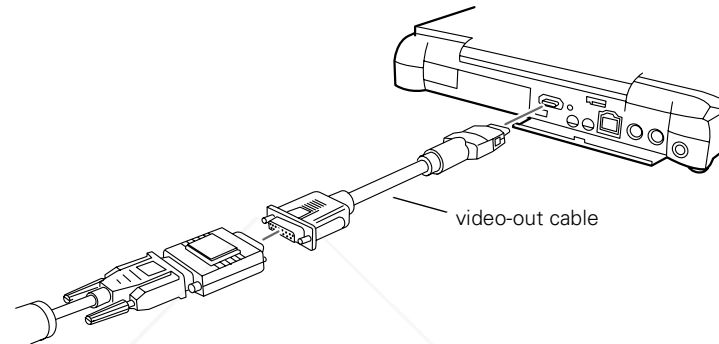



Connecting the Mouse and Serial Cables

If you want to use the remote control as a mouse or use the ELP Link IV software, you need to connect the main cable. It provides connectors for:

- The Mac mouse or USB cable (to use the remote control as a mouse)
- The Mac serial cable (to use the ELP Link IV software)

Refer to this illustration while following the steps below.

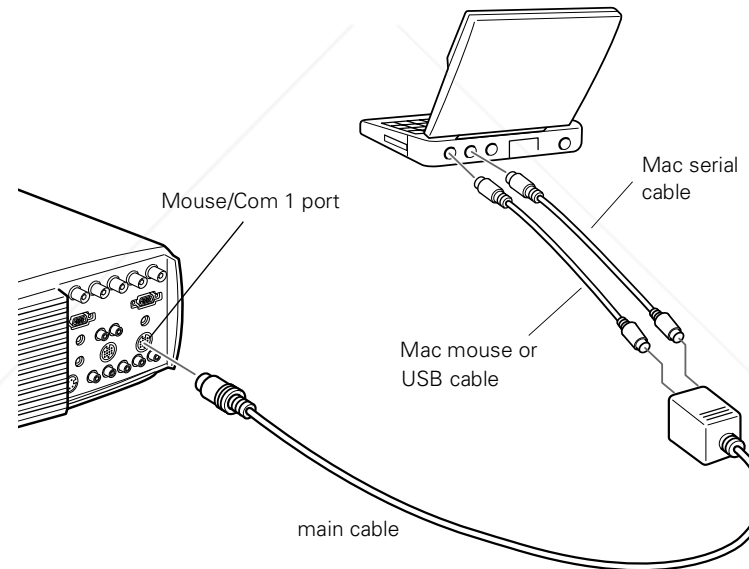

Discount-Merchant.com (800) 281-8860

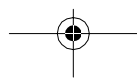

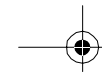

1. Connect the round end of the main cable to the projector's Mouse/Com 1 port. (Use the Mouse/Com 2 port if you are connecting a second computer.)

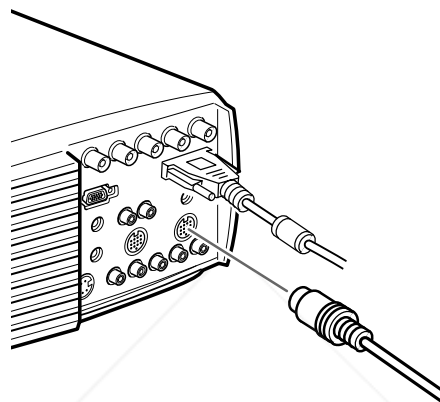

2. To use the remote control as a wireless mouse, connect one end of the projector's Mac mouse or USB cable to the MOUSE terminal on the large end of the main cable.

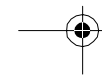
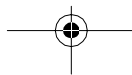
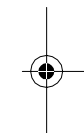
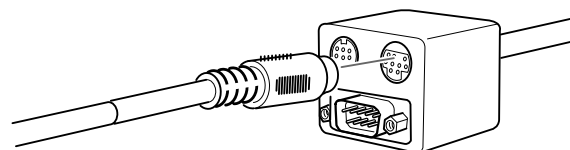



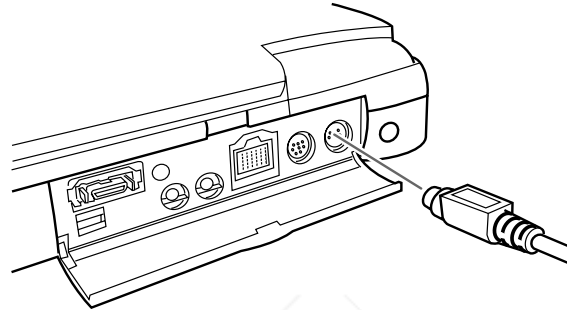

3. Connect the other end of the Mac mouse or USB cable to the mouse or USB port on the back of the PowerBook.

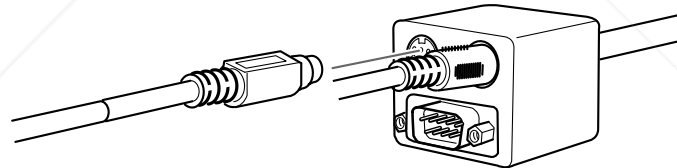

4. To use the ELP Link IV software or program new effects for the Effects buttons on the remote control, connect one end of the Mac serial cable to the MAC SERIAL terminal on the large end of the main cable.



5. Connect the other end of the serial cable to the  printer/modem port on the back of your PowerBook.

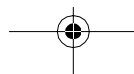

Connecting the Audio Cable

1. If you will be using audio, connect one end of the audio cable to the Audio 1 port on the projector. (Use the Audio 2 port if you are connecting a second computer.)

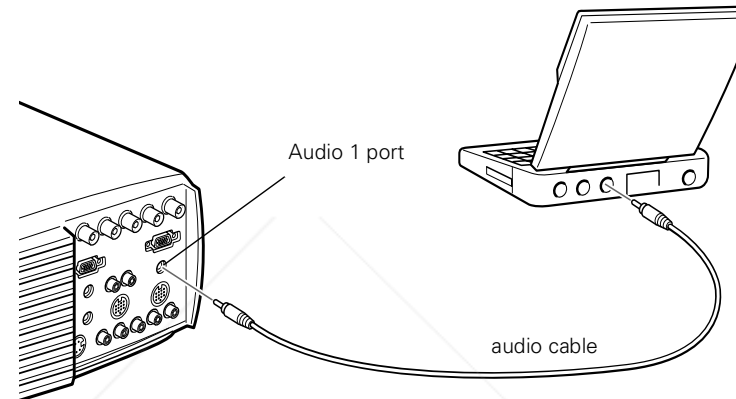

2. Connect the other end of the audio cable to the audio-out port on your PowerBook.

Note: After you turn on the projector and computer, you'll need to choose Mirroring in the Display Control Panel if you set up your configuration to display on the LCD screen as well as the projector screen.

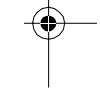
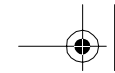

Connecting to a High-End Workstation

Your PowerLite projector is capable of remapping input resolutions up to 1600×1200 pixels. Since 1280×1024 pixels is the default resolution for most leading workstations, this capability makes these projectors the best portable solution for the display of workstation video output.

There is no standard for workstation video output. Those workstations that follow the SXGA standard and use the HD15 connector don't need an adapter cable.

Contact your audio/video dealer for information on connecting your workstation.

Connecting to a Video Source

You can connect a VCR, camcorder, laser disc player, DVD player, or any other compatible video image source to your projector.

The projector can receive composite video, S-Video, or component video. Your equipment has composite video if your video source has a one-pin RCA video port. Your equipment has S-Video if your video source has a four-pin (mini-DIN) video port. Your equipment has component video if your video source has a three-connector (Y, R-Y, B-Y) video port.

Note: The projector is not compatible with a cable TV-style F connector.



Discount-Merchant.com (800) 281-8860

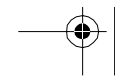
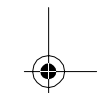
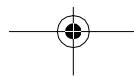

You can connect the projector to an S-Video source, a composite video source, and a component video source at the same time. However, the projector automatically selects the S-Video as the video source.

The projector supports HDTV, NTSC, PAL, and SECAM video formats, and automatically detects and identifies the video format. However, you can specify that a single broadcast format be detected. (See Chapter 3.) Note that the projector will then be able to detect only one type of video signal.

The type of cable you use to connect the video source to the projector depends on whether you have composite video, S-Video, or component video. For composite video, use the RCA audio and RCA video cable supplied with the projector. For S-Video, use the S-Video cable supplied with your video device or obtain one from your computer or video equipment dealer. For component video, use the BNC type cable that came with your video source. The illustration below shows the S-Video, component, and composite connectors.

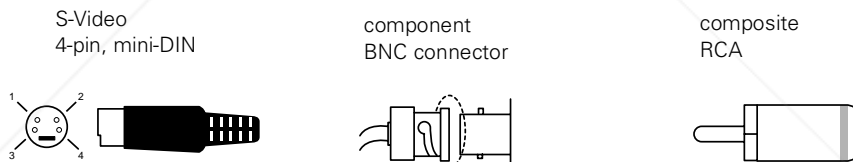

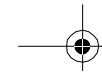

To connect a video source to the projector:

1. Turn off the projector and video source if they are on.
2. If your video source uses a small, round, one-prong composite (RCA) video connector, you'll need the RCA video cable that comes with the projector. If your video source uses a large, round, four-prong S-Video connector or a BNC type connector, you will need to purchase the appropriate cable or use the cable that came with your video source.
3. For composite video, connect the yellow RCA plug on one end of the RCA video cable to the projector's Video port. Connect the other yellow RCA plug to the video-out port of your video source.

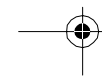
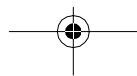
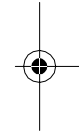
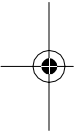
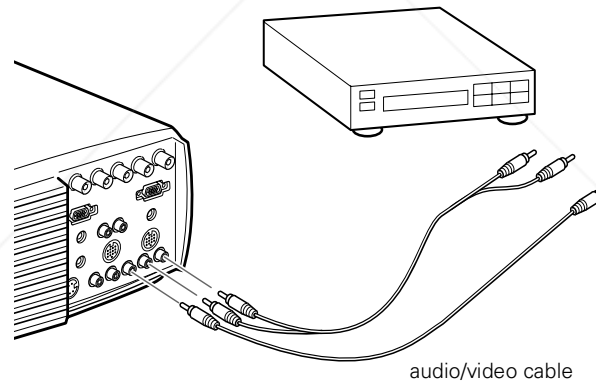

4. Connect the RCA audio cable to the Audio ports of the projector: insert the white plug into the L port and the red plug into the R port. Connect the plug at the other end of the RCA audio cable to the audio output ports of the video source.
5. For S-Video, insert one end of an S-Video cable into the projector's S-Video connector. Insert the other end into the S-video-out port of your video source.

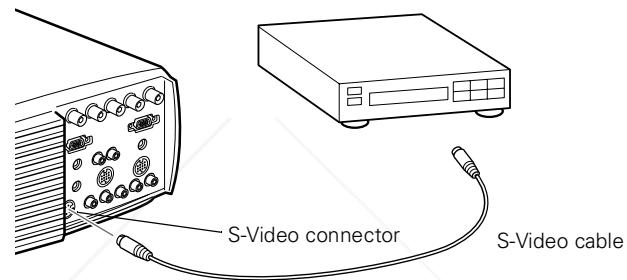

6. For component video, insert three ends of a BNC cable into the projector's R/R-Y, G/Y, and B/B-Y ports. Insert the opposite ends of the cable into the Y/Video, C/R-Y, and B-Y ports on your component video source. (Don't insert any of the cable ends into the HD/Sync and VD ports.)

Note: Use a standard BNC cable, which you can purchase from any computer store. The Computer 2/BNC video cable supplied by EPSON as an optional accessory does not work with component video.



Connecting to an External Speaker or PA System

Although the projector's internal speakers are enough for most small- or medium-size rooms, you can connect the projector to an external speaker or public address (PA) system for large rooms or to gain maximum benefit from the projector's built-in 3D sound function.

To connect the projector to an external sound system, you need to obtain an RCA-to-3.5 mm stereo audio cable. You can get one from your computer dealer.

1. Turn off the projector and speaker or PA system if they are on.
2. Connect the cable's 3.5 mm stereo miniplug to the projector's Audio Out port.

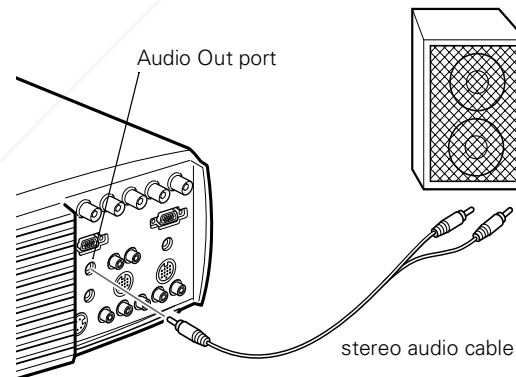

Discount-Merchant.com (800) 281-8860

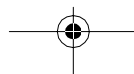



Note: EPSON offers the Mediaphile PAS (personal audio system) and the Mediaphile CVS (clear voice system) for external amplification. See page 5 for ordering information.

3. Connect the RCA plugs to the external amplified speaker or PA system. Insert the cable's red plug into the Audio R port, and the white plug into the Audio L port.

Note: The internal speakers are disabled when an external audio system is used.

Turning the Equipment On and Off

It's best to turn on the projector and its attached equipment in the following order:

1. Video source (such as a VCR), if your video source is not your computer
2. Audio source (if different from computer or video source)
3. Computer
4. External amplified speaker or PA system (if necessary)
5. Projector (follow the steps in the next section)

When you are ready to turn off the equipment, turn them off in the reverse order.

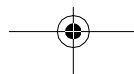
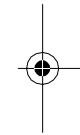



Turning the Projector On and Off

Follow these steps to turn on the projector:

1. Connect one end of the power cord to the projector's power inlet.
2. Connect the other end to a grounded electrical outlet. The power light on the projector's control panel turns orange, indicating that the projector is in sleep mode. (The projector is not turned on yet.)
3. Remove the projector lens cap.
4. Press the POWER button on the remote control or control panel to turn on the projector. The power light flashes green as the projector warms up.

If computer or video equipment is attached, the computer or video signal is projected. Allow about 30 seconds for full illumination.

Warning: Never look into the lens when the lamp is on. This can damage your eyes. It is especially important that children not look into the lens.

When you want to stop projecting images, press the POWER button. A confirmation message appears. Press the POWER button again. The fan remains on and the projection lamp light flashes orange for about 60 seconds as the projector cools down. When the projector has cooled down, flashing stops. The power light remains orange.

Note: If you press the POWER button to turn the projector back on while the power light is orange, there may be a delay before a projected image appears.



Discount-Merchant.com (800) 281-8860

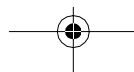
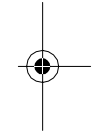
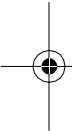

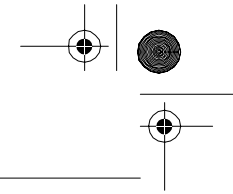

When you are done using the projector, unplug the power cord.

Never unplug the power cord when the power light is green; this may damage the lamp.

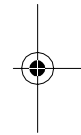
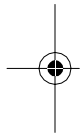

Discount-Merchant.com (800) 281-8860

THE TRUSTED SOURCE FOR PROJECTOR LAMPS AND ACCESSORIES

Turning the Equipment On and Off

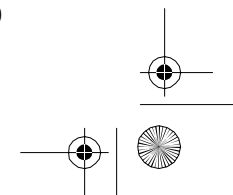
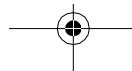
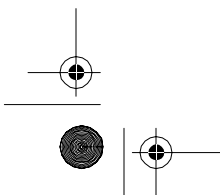

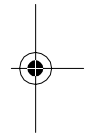
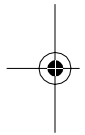

FixYourDLP.com

Sponsored by UM

Discount-Merchant.com (800) 281-8860

THE TRUSTED SOURCE FOR PROJECTOR LAMPS AND ACCESSORIES

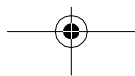

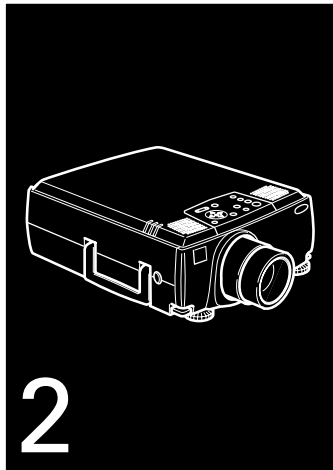

Using the Projector

This chapter provides the following information about using your projector:

- Positioning the projector relative to the screen
- Focusing and positioning the screen image
- Resizing the projected image
- Sleep mode
- Controlling the projector with the remote control and the control panel
- Monitoring the projector's operating status



Discount-Merchant.com (800) 281-8860
THE TRUSTED SOURCE FOR PROJECTOR LAMPS AND ACCESSORIES

The illustration below identifies the parts of your projector.

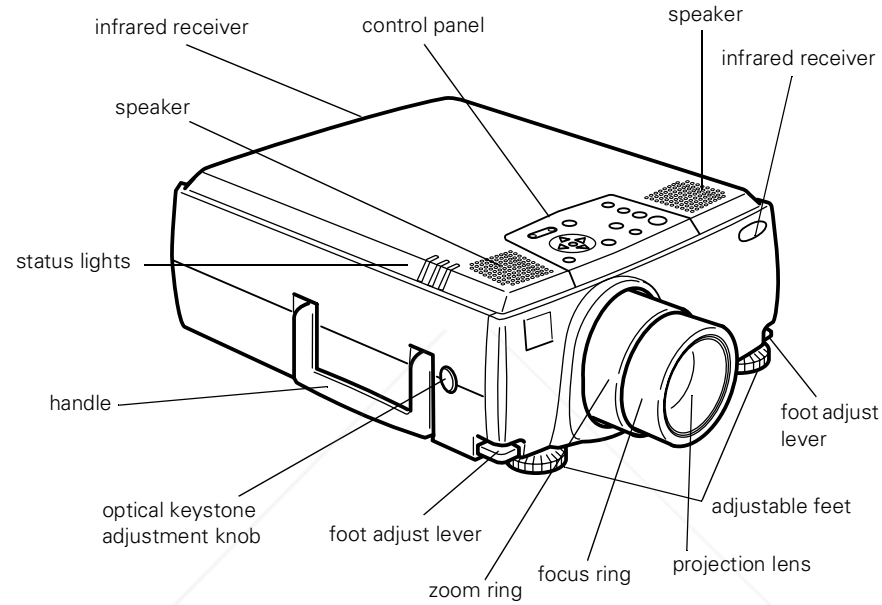

Positioning the Projector

Your projector supports front, rear, and ceiling projection, allowing you to choose the best method for displaying your images. If you use rear or ceiling projection, you need to select this in the projector's Advanced menu. See page 97 for more information.



Discount-Merchant.com (800) 281-8860

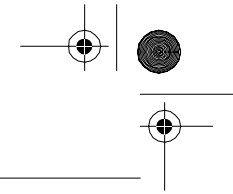

To get the best results when projecting your images, it's important to position the projector at the proper height and distance relative to the screen.

When projecting from a table or desk, place the projector so the lens is aligned as closely as possible with the bottom of your screen:

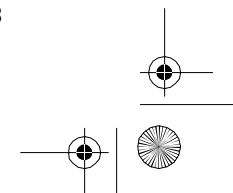
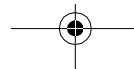
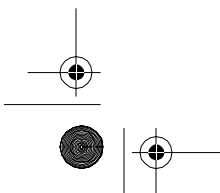
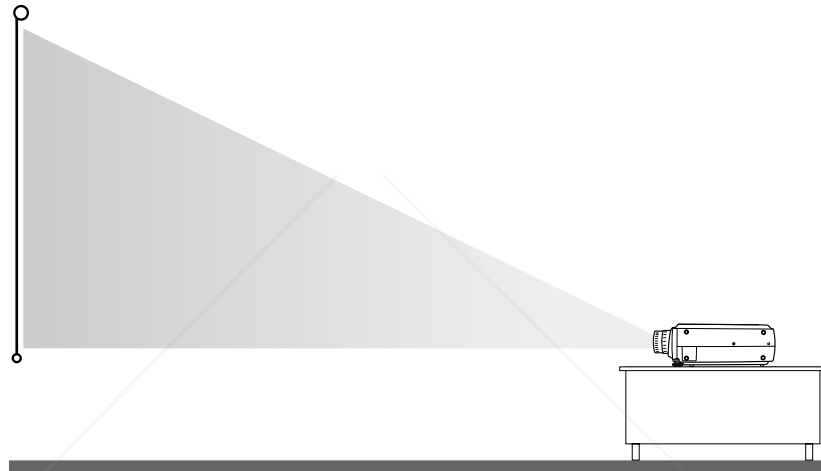



When projecting from the ceiling, align the lens as closely as possible with the top of your screen:



Using the Keystone Feature

In circumstances where the lens cannot be properly aligned, use the projector's Keystone function to help maintain optimum screen geometry.

- Press the Optical Keystone Adjustment knob on the side of the projector (next to the handle). When the knob pops out, turn it clockwise or counterclockwise to move the lens up or down. When you're finished, press the knob back in.
- Adjust keystone correction digitally by pressing the Keystone button on the control panel to increase or decrease the image adjustment. This feature allows you to correct up to a $\pm 20^\circ$ tilt, maintaining an aspect ratio of 4:3. Using the ELP Link IV software, you can correct up to a $\pm 30^\circ$ tilt.



Discount-Merchant.com (800) 281-8860

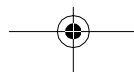
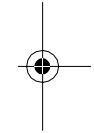
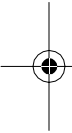



Calculating Image Size and Projection Distance

The distance between the projector and the screen determines the actual image size. To determine the exact distance required for a particular image size (or to determine the size of an image at a particular distance), use the formulas given below. (Remember that the size of the image can be changed by rotating the zoom ring; see page 69 for more information.)

Standard Lens Calculations

To determine the maximum and minimum diagonal size of an image when you know the projection distance:

☐ **Inches:**

$$\text{Maximum diagonal size} = (0.676 \times \text{projection distance}) + 2.293$$

$$\text{Minimum diagonal size} = (0.483 \times \text{projection distance}) + 1.639$$

☐ **Centimeters :**

$$\text{Maximum diagonal size} = (1.71 \times \text{projection distance}) + 5.824$$

$$\text{Minimum diagonal size} = (1.22 \times \text{projection distance}) + 4.163$$

To determine the projection distance when you know the diagonal size of the screen image:

☐ **Inches:**

$$\text{Maximum projection distance} = (2.070 \times \text{diagonal size}) - 3.393$$

$$\text{Minimum projection distance} = (1.480 \times \text{diagonal size}) - 3.393$$

☐ **Centimeters:**

$$\text{Maximum projection distance} = (5.257 \times \text{diagonal size}) - 8.6182$$

$$\text{Minimum projection distance} = (3.759 \times \text{diagonal size}) - 8.6182$$



Discount-Merchant.com (800) 281-8860

THE TRUSTED SOURCE FOR PROJECTOR LAMPS AND ACCESSORIES

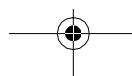

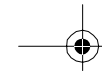

For example, here are the measurements for three installations:

Image size (diagonal)	Horizontal distance from projector to screen	
	Minimum	Maximum
300 inches* (762 cm)	460.6 inches (11.7 m)	586.6 inches (14.9 m)
200 inches (508 cm)	307.1 inches (7.8 m)	389.8 inches (9.9 m)
100 inches (254 cm)	153.5 inches (3.9 m)	192.9 inches (4.9 m)

* For an image size of 300 inches, the projector may be up to 52.1 feet away from the screen, depending on the setting of the zoom ring.

Long Throw Zoom Lens Calculations (ELPLL02)

To determine the maximum and minimum diagonal size of an image when you know the projection distance:

Inches:

Maximum diagonal size = $(0.487 \times \text{projection distance}) + 2.336$

Minimum diagonal size = $(0.286 \times \text{projection distance}) + 1.458$

Centimeters:

Maximum diagonal size = $(1.2369 \times \text{projection distance}) + 5.9334$

Minimum diagonal size = $(0.7264 \times \text{projection distance}) + 3.7033$

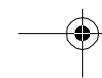
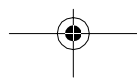
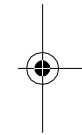
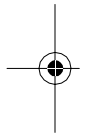



To determine the projection distance when you know the diagonal size of the screen image:

Inches:

Maximum projection distance = $(3.492 \times \text{diagonal size}) - 5.091$

Minimum projection distance = $(2.053 \times \text{diagonal size}) - 4.795$

Centimeters:

Maximum projection distance = $(8.8696 \times \text{diagonal size}) - 12.9311$

Minimum projection distance = $(5.214 \times \text{diagonal size}) - 12.1793$

Short Throw Zoom Lens Calculations (ELPLW01)

To determine the maximum and minimum diagonal size of an image when you know the projection distance:

Inches:

Maximum diagonal size = $(0.876 \times \text{projection distance}) + 3.793$

Minimum diagonal size = $(0.730 \times \text{projection distance}) + 3.029$

Centimeters:

Maximum diagonal size = $(2.2250 \times \text{projection distance}) + 9.6342$

Minimum diagonal size = $(1.8542 \times \text{projection distance}) + 7.6936$

To determine the projection distance when you know the diagonal size of the screen image:

Inches:

Maximum projection distance = $(1.369 \times \text{diagonal size}) - 4.147$

Minimum projection distance = $(1.142 \times \text{diagonal size}) - 4.331$

Centimeters:

Maximum projection distance = $(3.4772 \times \text{diagonal size}) - 10.5333$

Minimum projection distance = $(2.9006 \times \text{diagonal size}) - 11.0007$



Discount-Merchant.com (800) 281-8860

THE TRUSTED SOURCE FOR PROJECTOR LAMPS AND ACCESSORIES

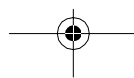



Fixed Short Throw Lens Calculations (ELPLR01)

To determine the diagonal size of an image when you know the projection distance:

- **Inches:**
Diagonal size = $(1.239 \times \text{projection distance}) + 3.415$
- **Centimeters:**
Diagonal size = $(3.1470 \times \text{projection distance}) + 8.6741$

To determine the projection distance when you know the diagonal size of the screen image:

- **Inches:**
Projection distance = $(0.807 \times \text{diagonal size}) - 2.756$
- **Centimeters:**
Projection distance = $(2.0497 \times \text{diagonal size}) - 7.0002$

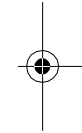
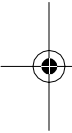

Discount-Merchant.com (800) 281-8860

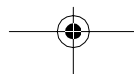

Focusing and Positioning the Screen Image

When an image appears on screen, check that it is in focus and correctly positioned on the screen.

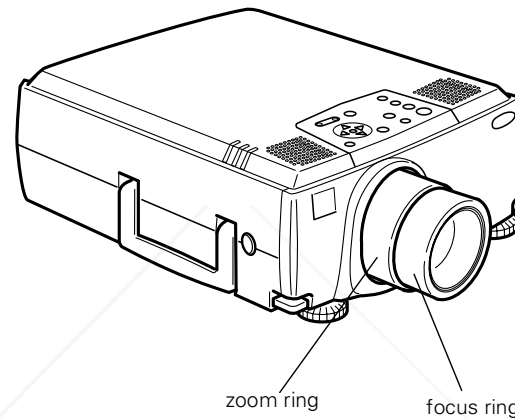

- ❑ To focus the image, rotate the focus ring (the inside ring on the lens).
- ❑ To adjust the size of the image, rotate the zoom ring (the outside ring). Rotate the zoom ring clockwise to make the screen image larger or counterclockwise to make it smaller.

Note: You can't adjust the screen image size with the fixed short throw lens.



If you need to raise or lower the image on the screen, extend or retract the two feet at the bottom of the projector as follows:

1. Stand behind the projector and support the front of it while you lift up on the foot adjust levers, located above the feet. This unlocks the adjustable feet so they can move up and down. Don't let the projector drop.

Caution: Don't hold or lift the projector by its lens. This can damage the lens.

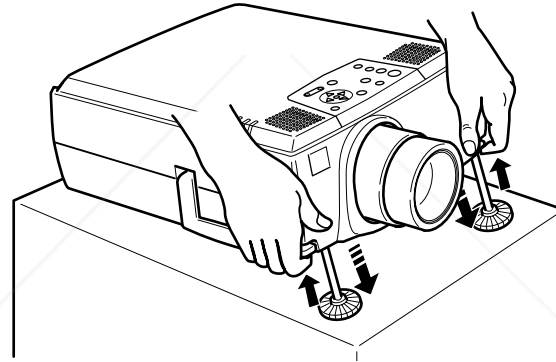

2. While lifting the levers, raise or lower the projector until the screen image is correctly positioned.
3. Release the levers to lock the feet in their new position.
4. If you want to fine-tune the height of the projector, turn the adjustable feet clockwise to raise the height, and counterclockwise to lower the height.



Discount-Merchant.com (800) 281-8860

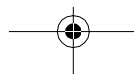



Note: You can also use the projector's Keystone function to help get optimum screen geometry. Adjust angle tilt optically by pressing the Optical Keystone Adjustment knob on the side of the projector (next to the handle), and then turning the dial clockwise or counterclockwise to move the lens up or down. Adjust angle tilt digitally by pressing the Keystone button on the control panel to increase or decrease the image adjustment. This feature allows you to correct up to a $\pm 20^\circ$ tilt, maintaining an aspect ratio of 4:3. Using the ELP Link IV software, you can correct up to a $\pm 30^\circ$ tilt.

Resizing the Projected Image

The **Resize** button lets you select the projection method for certain types of image signals input from a computer. Press the **Resize** button on the control panel or the remote control to select one of the following projection methods for your projector.

With images less than XGA (1024 × 768) for the PowerLite 8000i and less than SXGA (1280 × 1024) for the PowerLite 9000i, you can either display the image in the center of the projection area or display it full size.

With images greater than XGA size for the PowerLite 8000i and greater than SXGA size for the 9000i (up to 1600 × 1200 pixels), you can project the entire image in a compressed format. If you keep pressing the **Resize** button, the projector will pan around areas of the image in the original source resolution. When displaying the full screen, the projector automatically reduces the image size to the projector's maximum resolution.

*Note: The **Resize** button cannot be used with images at XGA (1024 × 768) resolution on the PowerLite 8000i or with images at SXGA (1280 × 1024) resolution on the PowerLite 9000i.*



Discount-Merchant.com (800) 281-8860

THE TRUSTED SOURCE FOR PROJECTOR LAMPS AND ACCESSORIES

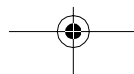
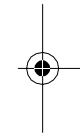

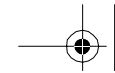

Sleep Mode

Sleep mode conserves electricity by automatically turning off the lamp after the projector has not been used for 30 minutes. In sleep mode, the projector's power status indicator is orange and only a minimum amount of the projector's circuitry remains on. This conserves electricity, cools the projector, and extends the life of the lamp. When the projector is in sleep mode, you can press the POWER button to start projecting images, or you can unplug the projector's power cord.

Controlling the Projector

You can use the remote control or the control panel on top of the projector to perform the following actions:

- Turn the power on or off
- Automatically set up the computer image
- Switch between input images (Computer 1, Computer 2, or Video)
- Access the projector menus to adjust the image, audio, video, and display settings
- Resize the projected image
- Freeze the display (remote control only)
- Temporarily display a blank screen
- Adjust or mute audio/video output
- Use custom functions (remote control only)
- Move the mouse pointer (remote control only)
- View online help



Discount-Merchant.com (800) 281-8860

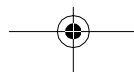
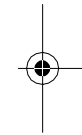
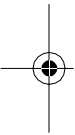

Using the Remote Control

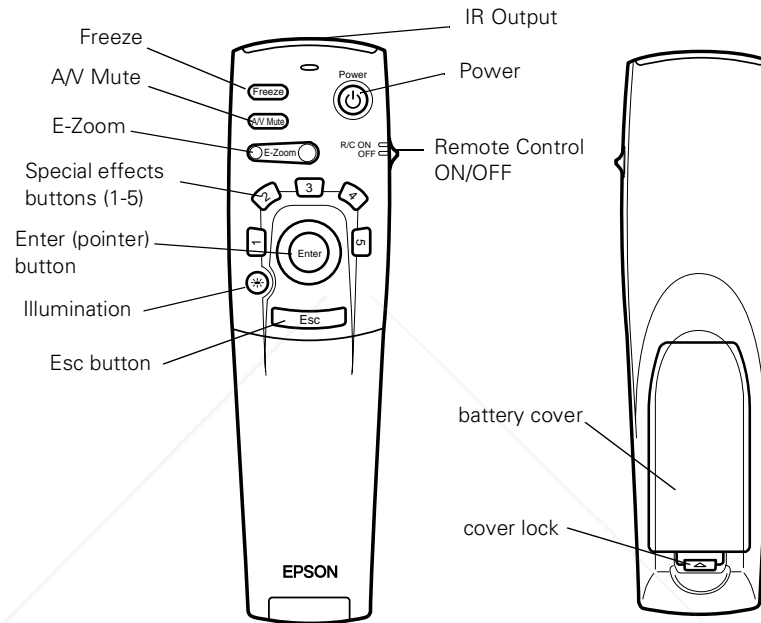

Additional remote control options are available by opening the cover just below the ESC button.

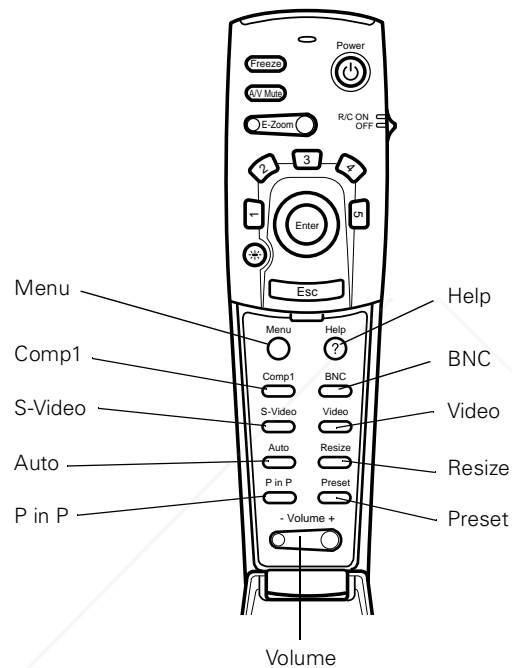

The remote control uses a line-of-sight infrared signal. To use the remote control, point it toward one of the remote control receivers located at the front and back of the projector. (See page 62.)

You can use the remote control up to about 32.8 feet (10 meters) from the projector. (This distance may be shorter if the remote control batteries are low.) You must also be within a $\pm 30^\circ$ angle from the front or rear sensor.



Discount-Merchant.com (800) 281-8860



Note: To be able to use the remote control as a wireless mouse, make sure you've connected the mouse cable to the projector and your computer. (See Chapter 1 for instructions.)

The five Special Effects buttons are preprogrammed with the following options:

- 1 Change the mouse cursor to a stamp
- 2 Draw a box
- 3 Use a marker pen
- 4 Draw a freehand line
- 5 Clear the screen

For information on changing these special effects, see page 107.

The projector may not respond to remote control commands in these conditions:

- The R/C (remote control) on/off switch is in the OFF position
- Batteries are weak
- Ambient light is too bright
- A certain type of fluorescent light is present
- A strong light source (such as direct sunlight) shines into the infrared receiver
- Other equipment emitting infrared energy is present (such as a radiant room heater)

Correct these conditions to use the remote control or control the projector from a computer.



Discount-Merchant.com (800) 281-8860

THE TRUSTED SOURCE FOR PROJECTOR LAMPS AND ACCESSORIES

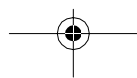



The following table summarizes the remote control functions.

Button	Function
Power	Starts or stops the projector.
Freeze	Keeps the current computer or video image on the screen.
A/V Mute	Turns off the audio and video, displaying either the black, blue or user logo background.
E-Zoom	Enlarges or reduces the image size from 1x to 4x (in 24 steps). Pressing the right side of the button enlarges the image, pressing the left side of the button reduces the image. To display a portion of an enlarged image which is outside of the display area, press the Enter button and scroll the image to the desired location.
RC ON/OFF	Turns the remote control on or off.
Effects buttons	Use to display preprogrammed special effects. Additional effects can be programmed using the ELP Link IV software, or control panel menu options. (See page 107 for instructions.)
Enter (Pointer button)	Use the Enter button to navigate the menus or use the remote as a mouse pointer when the projector is connected to the computer with the main cable and the mouse cable. When the image source is Computer, the Enter button acts as a mouse left-click.
Illumination	Illuminates all buttons on the remote control for 10 seconds.
Esc	Stops the current function. Pressing Esc while viewing a menu or the online help displays the previous screen or menu. When the image source is Computer, the Esc button acts as a mouse right-click.
Menu	Displays or hides the menu.

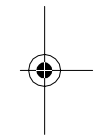

FixYourDLP.com

Sponsored by 

Discount-Merchant.com (800) 281-8860

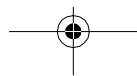



Button	Function
Comp1	Switches to the Computer 1 image.
S-Video	Switches to the S-Video image.
Auto	Optimizes the computer image.
P in P	Displays a video or S-video image in a subscreen on the main display. Use the Enter button to reposition the Picture in Picture (P in P) screen, or the E-Zoom button to enlarge or reduce the image. Changes made to the P in P screen location and size are automatically carried over to the next P in P session.
Help	Displays the online help menu.
Comp 2/BNC	Switches to the Computer2/BNC image.
Video	Switches to and toggles the Video image.
Resize	Switches the display dot mode and resize mode for VGA, SVGA, SXGA and UXGA input. You cannot resize the image if the input resolution matches the output resolution of the projector.
Preset	Saves and recalls settings (resolution, tracking, sync signal and position) for up to five different sessions. To save the current session settings, press the Preset button and it will be assigned the next available number 1 through 5. To recall a setting, press the Preset button a second time and move to the desired session number. To overwrite a saved setting, move to the setting you want to replace and press Enter. When the confirmation message appears, choose Yes and press Enter.
- Volume +	Adjusts the volume.

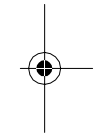

Discount-Merchant.com (800) 281-8860

THE TRUSTED SOURCE FOR PROJECTOR LAMPS AND ACCESSORIES

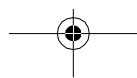

Using the Control Panel

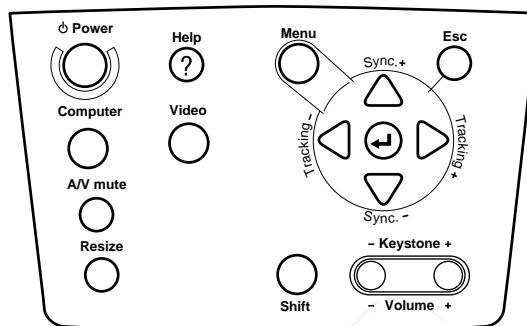

You can use the control panel to control the projector instead of the remote control. However, you can access the custom features only when you are using the remote control.

Image Calibration for Projector Software

Included on the ELP Link IV software CD is the Image Calibration for Projector (ICP) software. This program displays a full-screen image pattern which can be used to fine-tune control panel tracking and synchronization adjustments. To use ICP, with the projector connected and operating, open the ICP folder, and then double-click the ICP icon.

The following table summarizes the control panel functions.

Button	Function
Power	Starts or stops projection.
Help	Displays the online help menu.



Button	Function
Computer	Switches between Computer 1 and Computer 2.
Video	Switches to the video image. Pressing the button once switches to composite video, pressing it twice switches to S-Video.
A/V Mute	Turns off the audio and video, displaying either the black, blue or user logo background.
Resize	Switches the display dot mode and resize mode for VGA, SVGA, SXGA, and UXGA input. You cannot resize the image if the input resolution matches the output resolution of the projector.
Menu	Displays or hides the menu.
Esc	Stops the current function. Pressing Esc while viewing a menu or the online help displays the previous screen or menu. When the image source is Computer, the Esc button acts as a mouse right-click.
Up, down arrows (Sync+/Sync-)	Synchronizes the computer's graphic signal. Use these buttons to adjust an overall image that is fuzzy or streaked, or to select menu items during menu operations. Allows movement or selection of a menu, if a menu is displayed.
Left, right arrows (tracking-/ tracking+)	Matches the projector's internal clock to various computer graphic signals (tracking adjustment). Use these buttons to adjust an image with vertical fuzzy lines, or to change numeric settings during menu operations. Allows movement of a menu, if a menu is displayed.
Enter	Selects a menu option or the next menu/help screen. Pressing Enter when no menu or help screen is displayed optimizes the computer image.

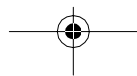
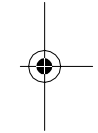



Button	Function
Shift	Pressing the shift and Keystone buttons at the same time increases or decreases the sound volume.
- Keystone +	Adjusts a trapezoid distorted image to normal, correcting up to a $\pm 20^\circ$ tilt.
- Volume +	Adjusts the volume when used in conjunction with the Shift button.

Projector Status Lights

The lights on top of the projector indicate the projector's operating status.

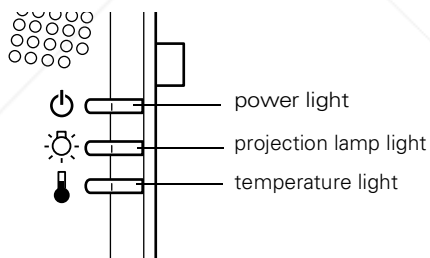

Caution: A red light warns you if a serious problem occurs. See Chapter 6 for what to do if a warning light comes on.



Discount-Merchant.com (800) 281-8860

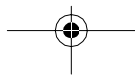



Power Light

Light status	Meaning
Steady orange	Projector is in sleep mode. (It is plugged in, but not projecting.)
Steady green	Power and lamp are on.
Flashing green	Projector is warming up. Allow about 30 seconds.
Flashing orange	Projector is cooling down.
Off	The projector is not plugged in or there is an internal projector problem.

Projection Lamp Light

Light status	Meaning
Orange and red flashing alternately	Projection lamp needs replacing.
Steady red	Projection lamp has burned out. Replace it to project images.
Flashing red	Problem with projection lamp or lamp power supply.
Off	Lamp is functioning normally.



Discount-Merchant.com (800) 281-8860

THE TRUSTED SOURCE FOR PROJECTOR LAMPS AND ACCESSORIES

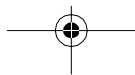

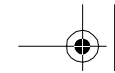

Temperature Light

Light status	Meaning
Flashing orange	Projector is too hot.
Steady red	Projector has turned off automatically because of overheating.
Flashing red	Problem with the cooling fan or temperature sensor.
Off	Projector is functioning normally.

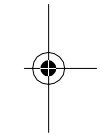

Discount-Merchant.com (800) 281-8860

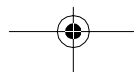
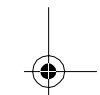

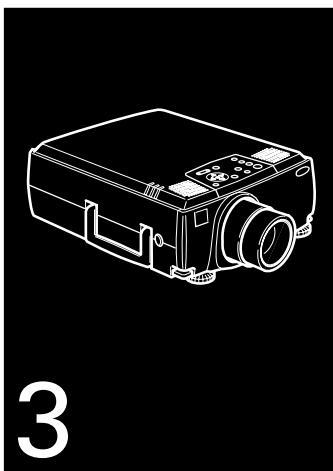

Using the Projector Menus

The eight projector menus allow you to control your projector from either the remote control or the control panel:

- The Video menu controls the look and quality of the projected image, and whether the image source is a computer or a video source (for example, a VCR).
- The Audio menu controls audio features, such as the volume level, treble, bass, and 3D sound.
- The Effect menu lets you modify the special effects assigned to the Effects buttons on the remote control and change the cursor speed.



Discount-Merchant.com (800) 281-8860

THE TRUSTED SOURCE FOR PROJECTOR LAMPS AND ACCESSORIES

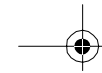

- ❑ The Setting menu allows you to set or adjust such projector options as the Picture in Picture (P in P) video source, blank screen color, image source message prompt, A/V Mute display option, and BNC input source.
- ❑ The User's Logo menu lets you capture and store a custom logo which may be used as a startup screen or with the A/V Mute option.
- ❑ The Reset All menu lets you restore the factory defaults for all the projector settings.
- ❑ The Advanced menu allows you to specify additional projector settings, including a language, startup logo, color matching, video signal, rear or ceiling projection, and the mouse/com port.
- ❑ The About menu provides information about H/V frequency, lamp hours, and computer or video selection.

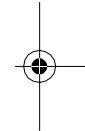
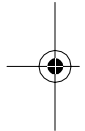

Discount-Merchant.com (800) 281-8860

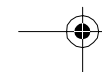
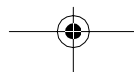

Accessing the Main Menu

To display the Main menu, press the Menu button on the control panel or the remote control. The Main menu appears.

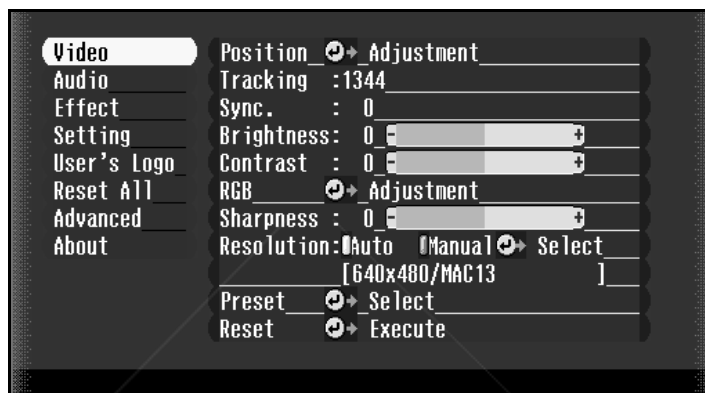

Press the Menu button again to hide the menu.

As you select a menu, a submenu of options appears to the right. The options available in some submenus vary, depending on whether the current image source is the computer or a video source. The illustration above shows a list of submenus for the Video menu when the image source is the computer.

Image Calibration for Projector Software

Included on the ELP Link IV software CD is the Image Calibration for Projector (ICP) software. This program displays a full-screen image pattern which can be used to fine-tune menu adjustments to tracking, synchronization, display position, brightness, contrast, RGB levels, color temperature, black and white levels, and screen sharpness.



Discount-Merchant.com (800) 281-8860
THE TRUSTED SOURCE FOR PROJECTOR LAMPS AND ACCESSORIES

To use ICP, with the projector connected and operating, open the ICP folder, and then double-click the ICP icon.

Changing a Menu Setting

To change a menu setting:

1. Press the Menu button on the control panel or remote control to display the Main menu.
2. Press the up or down arrows (control panel) or press up or down on the Enter button (remote control) to scroll through the menu choices.

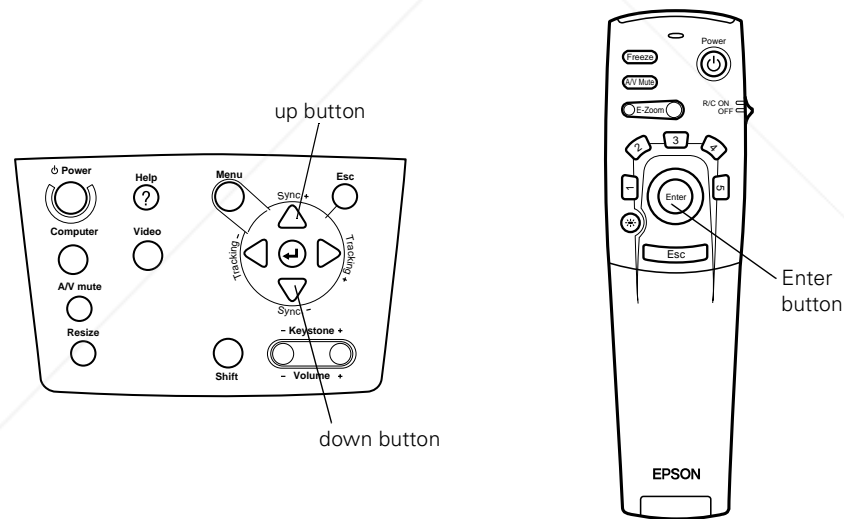

- Press the Enter button to display a submenu.

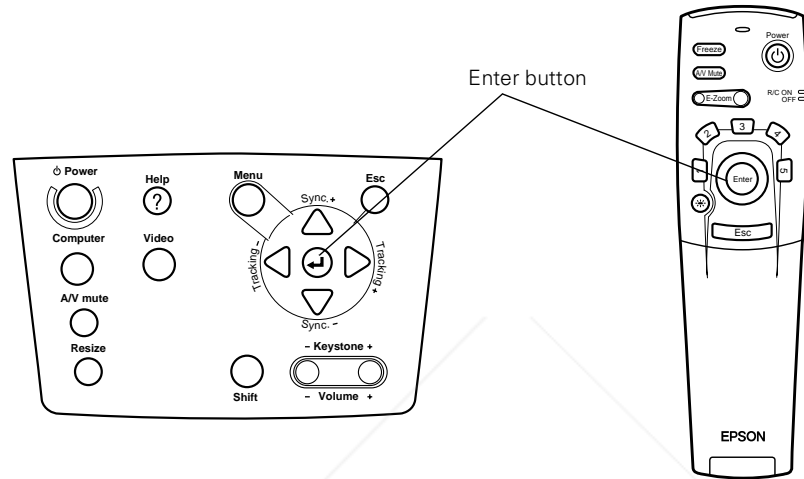

- Press the up or down arrows (control panel) or up or down on the Enter button (remote control) to scroll through the submenu choices.
- Press either the left or right arrow buttons (control panel) or right or left on the Enter button (remote control) to change a setting on one of the submenus.
- When you are finished changing settings, press ESC to go back to the Main menu. The changes are saved automatically.

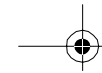

The settings available in each of the menus are described below.

Note: Some options are limited to being enabled (turned on) or disabled (turned off). Enabled options are indicated by a green light. Disabled options are blank.

Video Menu (Image Source = Computer)

The Video menu lets you make adjustments to the projected image. The following options are available when the image source is Computer 1 or Computer 2.

Note: The computer must be connected and operating, and the image source on the projector must be set to Computer 1 or Computer 2 for you to access these menu options.

Menu item	Description
Position	Select this item and then press the right arrow button (control panel) or press right on the Enter button (remote control) to enter the screen position adjustment mode. Then use the Enter button (remote control) or up, down, left, and right buttons (control panel) to move the screen position in the corresponding direction. When you finish making adjustments, press the Esc button to return to the Video menu.
Tracking	Matches the projector's internal clock to various computer graphic signals. Adjust this setting to remove vertical lines from the image.
Sync	Synchronizes with the tracking signal sent from the computer. Adjust this setting to correct fuzziness or screen flicker.

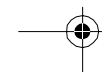
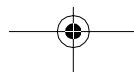
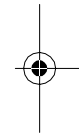



Menu item	Description
Brightness	Lightens or darkens the overall image. Increase brightness to lighten an image, or decrease it to darken the image.
Contrast	Adjusts the difference between light and dark areas. Increase the contrast to make light areas lighter and dark areas darker. Decrease it to minimize the difference between light and dark areas.
RGB	Adjusts the color balance of the input source. Select this item and then press the right arrow button (control panel) or press right on the Enter button (remote control) to enter the color adjustment mode. Then use the Enter button or up and down buttons (control panel) to select a color. Next, use the Enter button or left and right buttons (control panel) to adjust the selected color. Increase the color setting for more intense color on the screen, and lower the setting for less intense color. When you finish making adjustments, press the Esc button to return to the Video menu.
Sharpness	Adjusts the sharpness of the screen image.
Resolution	Specifies the video signal. In most cases, this setting should be left at the Auto setting allowing the system to automatically detect the video signal. If you want to specify a setting, however, you can select from 32 settings.
Preset	Allows you to save and recall settings for up to five computer sessions including the resolution, tracking, sync signal, and position.

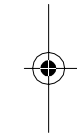

Discount-Merchant.com (800) 281-8860

THE TRUSTED SOURCE FOR PROJECTOR LAMPS AND ACCESSORIES

Video Menu (Image Source = Computer)

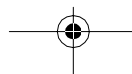



Menu item	Description
Reset	<p>Returns all menu items to their initial factory defaults.</p> <p>Select this item and then press the right arrow button (control panel) or right on the Enter button (remote control) to display the confirmation screen.</p> <p>Select Yes and then press the Enter button to reset the menu.</p> <p>If you change your mind, select No and then press the Enter button to clear the confirmation screen without changing any settings.</p>

Video Menu (Image Source = Video)

The Video menu lets you make adjustments to the projected image. The following options are available when the image source is Video.

Note: The projector's image source must be set to Video, and the video source (such as a VCR, DVD, or camcorder) must be connected and operating for you to access these menu options. (For example, the projector must actually be projecting the image from your video tape if you're using a VCR.)

Menu item	Description
Position	<p>Select this item and then press the right arrow button (control panel) or press right on the Enter button (remote control) to enter the screen position adjustment mode. Then use the Enter button (remote control) or up, down, left, and right buttons (control panel) to move the screen position in the corresponding direction.</p> <p>When you finish making adjustments, press the Esc button to return to the Video menu.</p>



Discount-Merchant.com (800) 281-8860

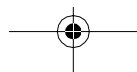
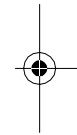

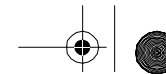

Menu item	Description
Brightness	Lightens or darkens the overall image. Increase brightness to lighten an image, or decrease it to darken the image.
Contrast	Adjusts the degree of difference between light and dark areas. Increase the contrast to make light areas lighter and dark areas darker. Decrease it to minimize the difference between the lightest and darkest areas of the image.
Saturation	Adjusts the color density. Increase the saturation for darker and more opaque color. Decrease it for lighter and less opaque color.
Tint (NTSC only)	Adjusts the red-green color balance of the screen. Increase tint to add more green, or decrease it to add more red.
Sharpness	Adjusts the sharpness of the screen image.
Reset	Returns all Video menu items to their initial factory defaults. Select this item and then press the right arrow button (control panel) or right on the Enter button (remote control) to display the confirmation screen. Next, select Yes and then press the Enter button to reset the Video menu. If you change your mind, select No and then press the Enter button to clear the confirmation screen without changing any settings.

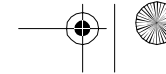
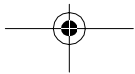
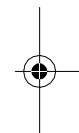

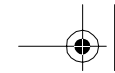

Audio Menu

Use the Audio menu to adjust the sound volume and quality of your audio.

Menu item	Description
Volume	Adjusts the volume level for the speakers and audio-out terminal. Increase the setting to raise the volume, or decrease it to lower the volume.
Treble	Adjusts the treble tone of the speakers. (Press the right arrow button on the control panel or press right on the remote's Enter button to increase the treble tone; press the control panel's left arrow button or left on the remote's Enter button to decrease the treble tone.)
Bass	Adjusts the bass tone of the speakers. See Treble for details.
3D Sound or SRS® SPACE and SRS CENTER	Adjusts the speakers' stereo input. For a more expansive stereo sound, increase this setting.
Reset	Returns all Audio menu items to their initial factory defaults. Select this item and then press the Enter button to display the confirmation screen. Next, select Yes and then press the Enter button to reset the Audio menu. If you change your mind, select No and then press the Enter button to clear the confirmation screen without changing any settings.

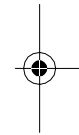

Discount-Merchant.com (800) 281-8860

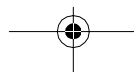

Effect Menu

The Effect menu lets you modify the effects assigned to the remote control Effects buttons.

Menu item	Description
Cursor/Stamp	Selects the stamp you want to use as the cursor graphic and a zoom rate.
Box	Selects a box color.
Marker	Selects the free line color and width.
Cursor Speed	Adjusts the cursor speed to Low, Middle, or High.
Reset	Returns all Effect menu items to their initial factory defaults. Select this item and then press the Enter button to display the confirmation screen. Next, select Yes and then press the Enter button to reset the Effect menu. If you change your mind, select No and then press the Enter button to clear the confirmation screen without changing any settings.

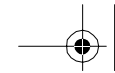

Setting Menu

The Setting menu allows you to set or adjust various projector options.

Menu item	Description
Keystone	Adjusts a trapezoid distorted image to a 4:3 rectangle, correcting up to a $\pm 20^\circ$ tilt.
P in P	Selects the image source (composite or S-Video) for the P in P subscreen.
Message	Specifies whether no screen, a black screen, a blue screen, or a user logo is displayed when the screen is blanked.
Prompt	Displays a temporary message (computer or video) identifying the image source.
A/V Mute	Displays a blue, black, or user logo screen when the audio/video is turned off.
BNC	Specifies the format for BNC input. If the source is computer, select RGB. If the source is video, select YcrCb. BNC will not display if the optional Video I/F board is not installed.
DPMS (Power Savings)	Turns the lamp power off when the appropriate DPMS signals are sent from the host computer.
Reset	Returns all Setting menu items to their initial factory defaults. Select this item and then press the Enter button to display the confirmation screen. Next, select Yes and then press the Enter button to reset the Setting menu. If you change your mind, select No and then press the Enter button to clear the confirmation screen without changing any settings.

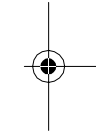
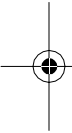

Discount-Merchant.com (800) 281-8860

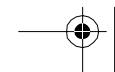
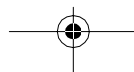

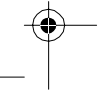
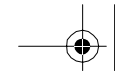

User's Logo Menu

The User's Logo menu allows you to capture and save a custom logo which can be used as a splash screen or with the A/V Mute button.

Capturing and Saving a Logo

Follow these steps to capture and save a logo:

1. Display the image (with the projector).
2. Press the Menu button on the control panel or remote control to display the Main menu.
3. Press the down arrow (control panel) or press down on the Enter button (remote control) to move to the User's Logo option.
4. Press ENTER (control panel or remote control) to display the User's Logo Setting window with the message "Do you use the present image as a user logo?"
5. Select YES and press Enter. A selection box displays over the image.
6. Use the arrow buttons on the control panel or the Enter button on the remote control to select the area of the image you want to use as the logo. Once you have selected the entire area, press Enter.
7. When the message "Do you use this image?" appears on the screen, select YES and press Enter. If you want to change the area selected, select NO and repeat step 6.

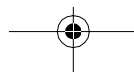
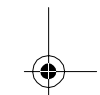
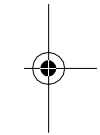

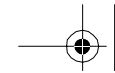

8. Use the arrow buttons on the control panel or the Enter button on the remote control to select a zoom rate, and then press Enter.
9. When the message “Do you save this user logo?” appears, select Yes and press Enter. If you do not want to save the logo, select No.

Note: Saving the logo may take a few moments. Do not use the projector or other sources (computer, video, speaker, etc.) while the logo is being saved.

10. When you see the message “Saving the user logo is completed,” press the Menu or Enter button to redisplay the Main menu.

Assigning the Logo to the A/V Mute Button

Follow these steps to assign the logo to the A/V Mute button:

1. Press the MENU button on the control panel or remote control to display the menu (if not already displayed).
2. Select the Setting menu and then press the Enter button on the control panel or remote control.
3. Select LOGO from the A/V Mute options.
4. Press the MENU button on the control panel or remote control.

Now you can press the A/V Mute button on the control panel or the remote control to display the user logo. Press it again to turn off the logo.

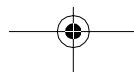
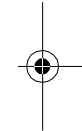
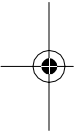

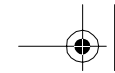

Reset All Menu

The Reset All menu lets you return all the projector settings to their default values. Select Reset All and press the Enter button on the control button or remote control to display the confirmation screen. Select YES to reset all the default settings or NO to cancel.

Advanced Menu

The Advanced menu lets you set additional projector options.

Menu item	Description
Language	Selects the language to be used in the menus: English, Japanese, French, German, Italian, Spanish, Portuguese, or Chinese.
Startup Screen	Displays your user logo during the projector's startup.
Color Setting	<p>Color Temp Adjusts the whiteness of the screen. Positive color temperature values provide a cold white; negative values provide a warmer white. Press the right arrow button (control panel) or press right on the Enter button (remote control) to increase the color temperature. Press the left arrow button (control panel) or press left on the Enter button (remote control) to decrease the color temperature.</p> <p>Black Level Press the right arrow button (control panel) or press right on the Enter button (remote control) to decrease black in the image.</p> <p>White Level Press the left arrow button (control panel) or press left on the Enter button (remote control) to decrease white in the image.</p>

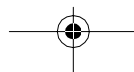
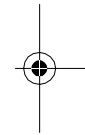
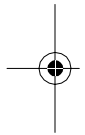

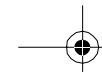

Menu item	Description
Video Signal	Specifies the input image signal mode. You can select AUTO, NTSC, NTSC 4.43, NTSC50, PAL, N PAL, M PAL, PAL 60 or SECAM.
Rear Projection	Mirrors the projected image on its Y-axis (left-right). Selecting ON turns mirroring on, while OFF turns it off (for a normal image). Turn on this option when projecting from behind onto a transparent screen.
Ceiling	Mirrors the projected image on its X-axis (top-bottom). Selecting ON turns mirroring on, while OFF turns it off (for a normal image). Turn this option on when the projector is mounted upside-down from the ceiling.
Mouse/Com	Locks and unlocks the Mouse/Com port. Select 1 to assign the wireless mouse control to the computer connected to the Mouse/Com 1 port only. Select 2 to assign the wireless mouse control to the computer connected to the Mouse/Com 2 port only. Selecting 1 ↔ 2 tells the projector to automatically switch wireless mouse control whenever the input source computer is changed.
Reset	Returns all Advanced menu items to their initial factory defaults. Select this item and then press the Enter button to display the confirmation screen. Next, select Yes and then press the Enter button to reset the Advanced menu. If you change your mind, select No and then press the Enter button to clear the confirmation screen without changing any settings.

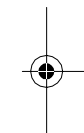

Discount-Merchant.com (800) 281-8860

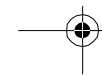
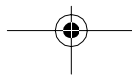

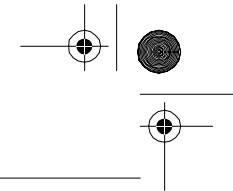

About Menu (Image Source = Computer)

When the image source is a computer, the About menu displays information about the projector's horizontal and vertical frequency, lamp hours, and computer connection.

Menu item	Description
Lamp	Displays the number of hours the current lamp has been used.
Frequency	Displays the projector's horizontal and vertical frequency.
Sync Polarity	Displays the sync polarity of the computer.
Sync Mode	Displays the sync mode of the computer.
Resolution	Displays the output resolution of the computer video output.
Refresh Rate	Displays the refresh rate of the computer video output.

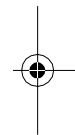
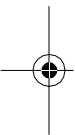

About Menu (Image Source = Video)

When the image source is video, the About menu displays information about the projector's lamp hours and video signal.

Menu item	Description
Lamp	Displays the number of hours the current lamp has been used.
Video Signal	Displays the input image signal mode.



Discount-Merchant.com (800) 281-8860

THE TRUSTED SOURCE FOR PROJECTOR LAMPS AND ACCESSORIES

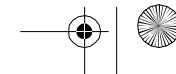
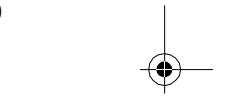
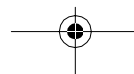
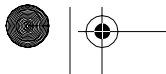

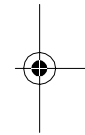
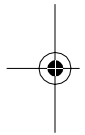
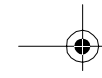

FixYourDLP.com

Sponsored by DM

Discount-Merchant.com (800) 281-8860

THE TRUSTED SOURCE FOR PROJECTOR LAMPS AND ACCESSORIES

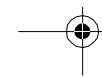
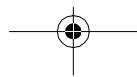

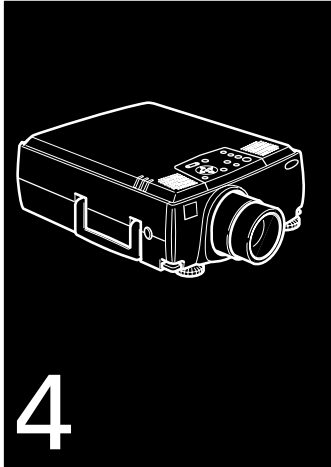

Using ELP Link IV

The ELP Link IV software is a utility you can run from your desktop or laptop computer to control projector features and draw special graphics on your screen. You can also use the software to reconfigure the Effects buttons on the remote control. This chapter describes how to:

- Install the software
- Start ELP Link IV
- Customize the remote control Effects buttons
- Control standard and special projector features



Discount-Merchant.com (800) 281-8860
THE TRUSTED SOURCE FOR PROJECTOR LAMPS AND ACCESSORIES



Installing the Software

ELP Link IV software can be used with the following operating systems:

- Windows 3.x
- Windows 95 or 98
- Windows NT 3.51 or 4.0
- Macintosh OS System 7.5.1 and OS System 8.x.

Connecting Needed Cables

Before installing the ELP Link IV software, make sure the projector is properly connected to your computer with the main and serial cables. See Chapter 1 for instructions.

Installing the Software for Windows

Follow these steps to install ELP Link IV for Windows 3.x, Windows 95 or 98, or Windows NT:

1. Turn on your computer and start Windows.
2. Insert the Projector Software CD into your CD-ROM drive.
3. If you have Windows 95, 98, or NT, the ELP Link IV Setup window should open automatically. If it doesn't, click Start and then Run. The Run dialog box appears. Type E:\SETUP (substitute the correct drive letter for your CD-ROM drive if it is not E), then press Enter or click OK.



Discount-Merchant.com (800) 281-8860

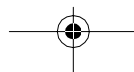
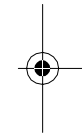
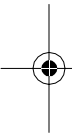

If you have Windows 3.x, in Program Manager click on the File menu, then on Run. The Run dialog box appears. Type E:\SETUP (substitute the correct drive letter for your CD-ROM drive if it is not E), then press Enter or click OK.

4. You see the ELP Link IV Setup screen listing the languages and options available for installation. Select the language you want for running the software from the dropdown list, and make sure ELP Link IV is checked.

If you don't have Adobe® Acrobat® Reader on your system, also check Acrobat Reader to install the program so you can view your online manual. Then click OK.

5. After a moment, you see the ELP Link IV Welcome screen. Click Next.
6. You see the Software License Agreement screen. Read the agreement and click Yes.
7. Follow the instructions on the screen to select a directory or a folder for the software. Then the Installer copies the ELP Link IV files to your system.
8. When the installation is complete, click Finish.
9. If you selected to install Acrobat Reader, follow the on-screen instructions to install it.

Note: If you ever select Always Unconnected and Execute from the Option menu, always uncheck the setting before exiting ELP Link IV so the program starts correctly the next time you use it.



Discount-Merchant.com (800) 281-8860

THE TRUSTED SOURCE FOR PROJECTOR LAMPS AND ACCESSORIES

Installing the Software

103



Installing the Software for a Macintosh

Follow the steps below to install the software for the Macintosh.

Note: You cannot currently use the ELP Link IV software with a Power Macintosh G3 or iMac. Check with your dealer for future support.

1. Insert the Projector Software CD into your CD-ROM drive.
2. Open the CD-ROM drive icon, if necessary.
3. Double-click the Installer icon.
4. You see a dialog box asking you to select a language for the software. Select a language and click OK.
5. You see the Software License Agreement screen. Read the agreement and click Accept.
6. You see the Program Install screen. Make sure ELP Link IV is selected and, if necessary, Acrobat Reader, and then click OK.
7. You see the Folder to Install screen. Select the folder where you want to install the software and click Install.
8. When the installation is finished, close the ELP Installation folder.

Note: If you ever select Always Unconnected and Execute from the Option menu, always uncheck the setting before exiting ELP Link IV so the program starts correctly the next time you use it.

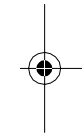

Discount-Merchant.com (800) 281-8860

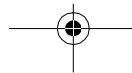



Starting ELP Link IV

Follow the steps in the appropriate section below to launch the software. If you're using the remote control as a mouse, use the Enter button to position the cursor and click the Enter button to launch the software.

Note:

- If you have a Macintosh, your screens may look slightly different than the screens in this chapter.*
- If you have questions while using ELP Link IV, choose Help Topics from the Help menu.*

Starting the Program from Windows

1. If you have Windows 95, 98, or NT, click Start, select Programs, ELP Link IV, and then click the ELP Link IV program icon. If you have Windows 3.x, double-click the ELP Link IV program icon in the Windows 3.x ELP Link IV program group.

The ELP Link IV program icon appears minimized at the bottom of your screen, or on the taskbar if you're running Windows 95, 98, or NT.



Discount-Merchant.com (800) 281-8860

THE TRUSTED SOURCE FOR PROJECTOR LAMPS AND ACCESSORIES

Starting ELP Link IV

105

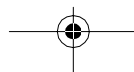





Note: If you see a prompt asking you to select a port or open the software with the projector disconnected, it may be because the projector is disconnected or is connected to an incorrect COM port. If you want to run the software without the projector connected, select Unconnected and Execute. If it is connected, click Select a port and operate again. Then select the COM port you're using on the next screen.

2. Click the minimized program icon. The ELP Link IV main window appears.

Starting the Program on a Macintosh

1. Open the ELP Link IV folder.
2. Double-click the ELP Link IV icon.

If you're launching ELP Link IV for the first time, select COM Port from the Option menu, then choose either the  printer or  modem port (whichever port you connected the serial cable to). Then open the Option menu and select Property Setting to display the ELP Link IV main window.

Changing the COM Port Assignment

If you did not select the correct COM (communication) port when setting up the software, or if you have changed the COM port to which the projector is connected, you can change the COM port setting from the ELP Link IV software.

1. Point to Select Port and Reconnect in the Options menu.
2. Choose a COM port from the list that appears.



Discount-Merchant.com (800) 281-8860

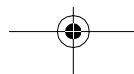

Customizing the Remote Control Effects Buttons

In addition to the preprogrammed effects, you can also assign new functions to the remote control Effects buttons from the ELP Link IV main dialog box.

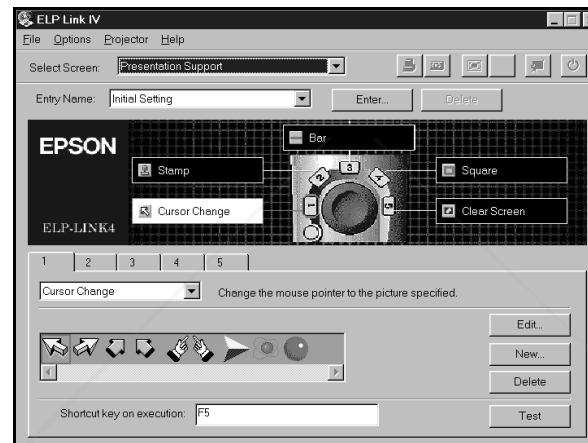

Function Description and Usage

To assign a new function to an Effects button on the remote control, click on the tab corresponding to the remote control Effects button you want to assign, then choose a function for it from the dropdown menu. Depending on the option selected, you can then make detailed selections such as color, shapes, width, and so on.

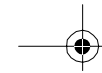

The following table describes these functions and how to use them.

Note: To program new effects for the Effects buttons, the ELP Link IV software must be running. Once you have pressed an Effects button, you can check the effect by using either your mouse or your remote control (if you've set up the remote control to function as a mouse and the computer is connected to the projector).

Function	Description and usage
Free Line	<p>Draws a free style line on the screen.</p> <p>Press the Effects button assigned to this effect. Move the cursor using the remote Enter button to draw the line. Press the Enter button to set the line end position. To draw another line, move the cursor away from the line you just created and press the Enter button again to start the new line.</p>
Line	<p>Draws a straight line on the screen.</p> <p>Press the Effects button assigned to this effect. Then press the Enter button once to define the line start position. Move the cursor using the remote Enter button, and then the Enter button again to define the line end position. To draw another line, move the cursor away from the line you just created and press the Enter button again to define the new line start position.</p>
Ellipse	<p>Draws an ellipse (oval) on the screen.</p> <p>Press the Effects button assigned to this effect. Then press the Enter button once to define the start position of the ellipse. Move the cursor using the remote Enter button. Then press the Enter button again to define the end position of the ellipse. To draw another ellipse, move the cursor away from the one you just created and press the Enter button again to define the start position for the new ellipse.</p>

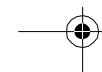
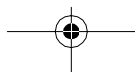
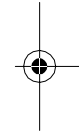
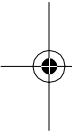

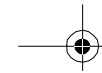

Function	Description and usage
Square	<p>Draws a square on the screen.</p> <p>Press the Effects button assigned to this effect. Then press the Enter button once to define the position of one corner of the square. Move the cursor using the remote Enter button. Then press the Enter button again to define the position of the opposite corner of the square. To draw another square, move the cursor away from the one you just created and press the Enter button again to define the start position for the new square.</p>
Bar	<p>Creates a horizontal or vertical bar. You can use this function to highlight a portion of the screen with a horizontal or vertical bar.</p> <p>Press the Effects button assigned to this effect. Move the bar using the remote Enter button. Press the Enter button to lock the bar in place. To draw another bar, move the cursor away from the bar you just created and press the Enter button again to lock the new bar in place.</p>
Stamp	<p>Leaves one or several copies of a pre-selected image on the screen.</p> <p>Press the Effects button assigned to this effect. Use the Enter button to place the cursor where you want the stamp to appear. Then press the assigned Effects button to display the stamp. To draw another stamp, move the cursor away from the stamp you just created and press the Enter button again to lock the new stamp in place.</p>
Cursor Change	<p>Changes the cursor shape.</p> <p>Press the assigned Effects button to change the cursor shape.</p>
Sound	<p>Plays a selected sound effect.</p> <p>Press the Effects button assigned to this effect. Click the Refer To button to select the .wav file you want to play and click Open. Press the assigned Effects button to play the sound.</p>

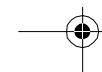
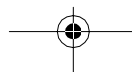
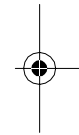



Function	Description and usage
Spot light	Creates a spotlight effect on the screen. Press the Effects button assigned to this effect. Use the Enter button to place the cursor where you want the spotlight to appear. Then press the assigned Effects button to display the spotlight. To draw another spotlight, move the cursor away from the spotlight you just created and press the Enter button again to lock the new spotlight in place.
Clear Screen	Clears all Effects functions previously executed. Press the assigned Effects button to clear the screen.
Key	Types a pre-defined key sequence. This is useful when you often need to type a sequence of characters into your computer. Press the assigned Effects button to automatically type the key sequence.

Note: To cancel or end a function, double-click with your mouse or press the Enter button twice (if you're using the remote control as a mouse).

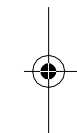

Discount-Merchant.com (800) 281-8860

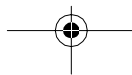

Assigning Functions



Each of the five Effects buttons is assigned a default function:

- 1 Change the mouse cursor to a stamp
- 2 Draw a box
- 3 Use a marker pen
- 4 Draw a freehand line
- 5 Clear the screen

If you want to assign a different function to a button, click the tab (1 through 5) that corresponds to the button number and select a new function from the dropdown list.

Setting Effects Options

Once you have assigned functions to one or more Effects buttons, you can specify detailed options for each function. You can also modify the detailed options assigned to the pre-programmed effects.

To set detailed options, click on the option you want to apply from the options displayed below the Effects Type dropdown list. (The options displayed depend on which functions are currently assigned to the Effects buttons.)

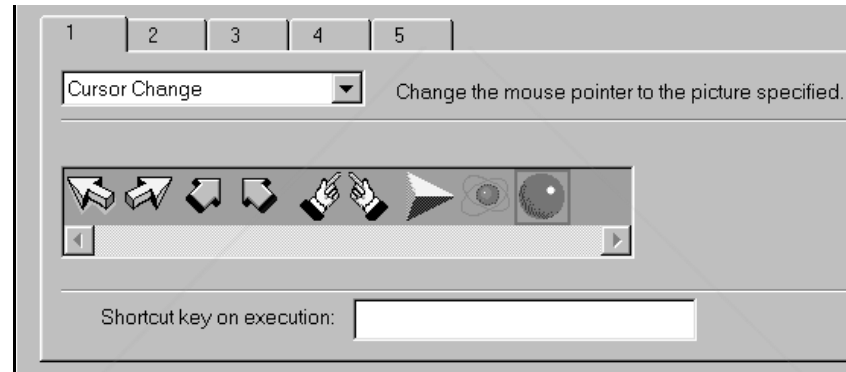

To test a setting, click the Test button and then click the left mouse button to start and stop each setting. To end the test, click the right mouse button. (If you are using the remote control as a mouse pointer, use the Enter and ESC buttons, respectively.)



The following table describes the options available for each function.

Function	Options	Description
Free Line	Width	Specify the line width, from 1 to 32 points.
	Color	Choose a color for the line.
	Transparent	Check this box to make the background text or image visible through the line.
Line	Width	Specify the line width, from 1 to 32 points.
	Grid	Specify whether to have the line “snap” to the corners of a grid by entering the size of the sides of the box, in pixels (dots).
	Color	Choose a color for the line.
	Transparent	Check this box to make the background text or image visible through the line.
Ellipse	Width	Specify the line width, from 1 to 32 points.
	Color	Choose a color for the line.
	Transparent	Click this check box to make the background text or image visible through the ellipse.
	Fill	Check this box to fill the ellipse with color.
Square	Width	Specify the line width, from 1 to 32 points.
	Color	Choose a color for the line.
	Transparent	Check this box to make the background text or image visible through the square.
	Fill	Check this box to fill the square with color.
	Track Shape	Check this box to round the corners of the square.

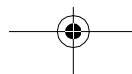
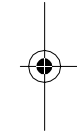



Function	Options	Description
Bar	Width	Specify the line width, from 1 to 300 points.
	Color	Choose a color for the bar.
	Direction	Choose Horizontal or Vertical.
	Transparent	Check this box to make the background text or image visible through the bar.
Stamp		Click on the stamp to be used.
		To create a new stamp, click New. The Stamp Edit screen appears, allowing you to create a new stamp using the line, pencil, square, ellipse, and color tools. To add the stamp to the collection, click Add. To close the screen, choose Close from the File menu.
		To edit a stamp, select it and then click Edit. After making your changes, click Save. You have the option to save the stamp as a new stamp, leaving the original intact, or to overwrite the existing stamp. To close the screen, choose Close from the File menu.
		To delete a stamp, select it and then click Delete. When the confirmation message displays, click Yes.
Cursor Change		Click on the cursor shape to be used.
		To create a new cursor image, click New. The Cursor Edit screen displays allowing you to create a new cursor using the line, pencil, square, ellipse, and color tools. To add the cursor to the collection, click Add. To close the screen, choose Close from the File menu.
		To edit a cursor, select it and then click Edit. After making your changes, click Save. You have the option to save the cursor as a new cursor image, leaving the original intact, or to overwrite the existing cursor. To close the screen, choose Close from the File menu.
		To delete a cursor, select it and then click Delete. When the confirmation message displays, click Yes.
Sound		Click Refer To to choose the desired .wav file. After selecting the file, click Open. To test the sound, click the Play button.

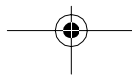
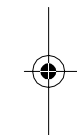



Function	Options	Description
Spot light	Width	Specify the line width, from 1 to 300 points.
	Color	Choose a color for the bar.
	Transparent	Check this box to make the background text or image visible through the spotlight.
Clear Screen	No options available.	
Key	<p>Enter up to 16 characters, including combinations such as Ctrl + A, in the Key to Enter field. The Backspace and Delete keys are also recorded. After entering the desired key, press Enter.</p> <p>Click the Delete All button to clear the current key assignment.</p> <p>Note: Although you can save multiple sets of key assignments, only one key set can be active at a time. Click the Enter button to save more than one set of key assignments.</p>	

Assigning Functions to the Keyboard

If you want to execute an effect using your keyboard, follow these steps:

1. Select the effect tab for which you want to assign function key execution.
2. Click the mouse in the Shortcut key on execution field and then press the function key you want to assign to this effect (F2 through F12).



Discount-Merchant.com (800) 281-8860

THE TRUSTED SOURCE FOR PROJECTOR LAMPS AND ACCESSORIES

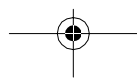

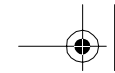

Saving and Recalling Effects Button Assignments

To save Effects button assignments, click Enter next to the Entry Name dropdown list. The Registering Function Settings dialog box appears.

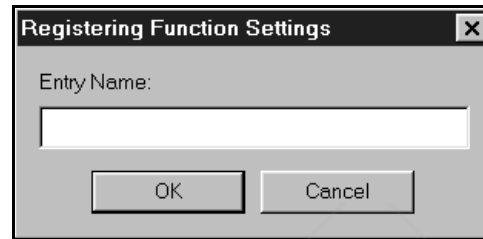

Specify a name for the current settings and click OK.

To recall a saved set of assignments, select its name from the Entry Name dropdown list.

To delete a set of assignments from the Entry Name menu, select its name and then click Delete. When the confirmation message is displayed, click Yes.

To exit without saving the settings, select Exit from the file menu.

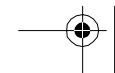
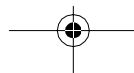
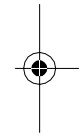



Controlling Projector Features

You can use the ELP Link IV software to control the following features:

- Changing projector settings
- Changing the test pattern
- Specifying an image gamma
- Creating a user logo

Using the Quick Change Toolbar

To quickly change some basic projector settings, click one of the toolbar buttons described below:

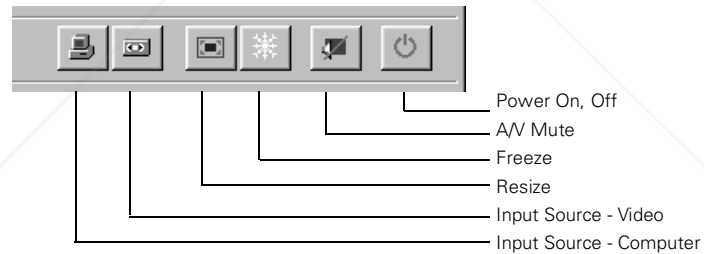

Changing Projector Settings

1. Choose Projector Control from the Select Screen dropdown list. You see the following window.

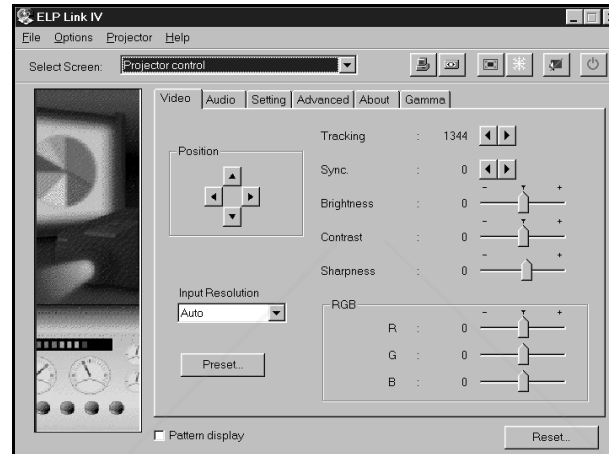

2. Click the tab for the settings you want to adjust.
3. Change one or more of the options, as desired. The options are described in the following tables.

Video Tab (Computer Input)

Option	Description
Tracking	Adjusts tracking to remove vertical lines.
Sync	Adjusts the sync (synchronization) to remove screen flicker.
Brightness	Adjusts screen brightness.
Contrast	Adjusts screen contrast.
Sharpness	Adjusts screen sharpness.
Color	Adjusts the balance of red, green, and blue in the image.
Position	Adjusts the horizontal and vertical screen position.
Input Resolution	Selects the signal format. You can select AUTO, PAL, NTSC, a specific resolution, or a preset setting. AUTO automatically adjusts the image to the signal received.
Preset	Saves and recalls settings (resolution, tracking, sync signal and position) from up to five different sessions. To save the current session settings, choose the present number from the dropdown list and click OK.
Pattern Display	Displays the test pattern currently selected.
Reset	Resets all fields to their default values.

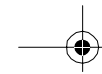

Video Tab (Video Input)

Option	Description
Tracking	Adjusts tracking to remove vertical lines.
Sync.	Adjusts the sync (synchronization) to remove screen flicker.
Brightness	Adjusts screen brightness.
Contrast	Adjusts screen contrast.
Sharpness	Adjusts screen sharpness.
Color	Adjusts the balance of red, green, and blue in the image.
Tint (NTSC only)	Adjusts the color tint.
Input Resolution	Selects the signal format. You can select AUTO, PAL, NTSC, a specific resolution, or a preset setting. AUTO automatically adjusts the image to the signal received.
Preset	Saves and recalls settings (resolution, tracking, sync signal and position) from up to five different sessions. To save the current session settings, choose the present number from the dropdown list and click OK.
Pattern Display	Displays the test pattern currently selected.
Reset	Resets all fields to their default values.

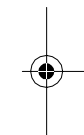

Discount-Merchant.com (800) 281-8860

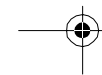
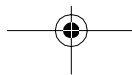

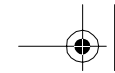

Audio Tab

Option	Description
Volume	Adjusts the sound volume.
Treble	Adjusts the treble tone.
Bass	Adjusts the bass tone.
3D Sound or SRS SPACE and SRS CENTER	Adjusts stereo sound effects. When you increase the number, the stereo effect is enhanced.
Pattern Display	Displays the test pattern currently selected.
Reset	Resets all fields to their default values.

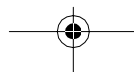
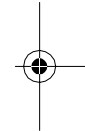
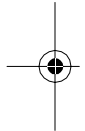



Setting Tab

Option	Description
Keystone	Adjusts a trapezoid distorted image to normal, correcting up to a $\pm 30^\circ$ tilt.
Prompt	Temporarily displays a prompt on the projector screen identifying which source (computer or video) is providing the image.
DPMS (Power Savings)	Turns the lamp power off when the appropriate DPMS signals are sent from the host computer.
P in P	Selects the image source (composite or S-Video) for the P in P subscreen.
BNC	Specifies the input image signal mode as either RGB or Y, R-Y, B-Y.
Message	Specifies whether a black screen, a blue screen, or a user logo is displayed when the screen is blanked.
A/V Mute	Displays a blue, black or user logo screen when the audio/video is turned off.
Pattern Display	Displays the test pattern currently selected.
Reset	Resets all fields to their default values.



Discount-Merchant.com (800) 281-8860

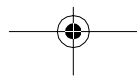

Advanced Tab

Option	Description
Startup Screen	Displays your user logo during the projector's startup.
Color Setting	Adjusts the temperature of the screen colors. Positive color temperature values provide a cold white; negative values provide a warmer white. You can also adjust the black and white levels.
Project From	Specifies that you want to project from the Ceiling or Rear Projection.
Cursor Speed	Specifies a cursor speed.
Video Signal	Specifies the input image signal mode. You can select AUTO, NTSC, NTSC 4.43, NTSC50, PAL, PAL N, PAL M, PAL 60, HDTV or SECAM.
Pattern Display	Displays the test pattern currently selected.
Reset	Resets all fields to their default values.

About Tab

Option	Description
Lamp	Displays the number of hours the current lamp has been used.
Frequency	Displays the projector's horizontal and vertical frequency.
Sync Polarity	Displays the sync polarity of the computer.
Sync Mode	Displays the sync mode of the computer.
Resolution	Displays the output resolution of the computer video output.

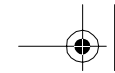

Option	Description
Pattern Display	Displays the test pattern currently selected.
Reset	Resets all fields to their default values.

Gamma Tab

Option	Description
Select Gamma	Specifies the desired gamma: Gamma 1 Provides a dynamic and contrastive image. Gamma 2 Provides an image between Gamma 1 and Gamma 3. Gamma 3 Provides a natural image.
Pattern Display	Displays the test pattern currently selected.
Reset	Resets all fields to their default values.

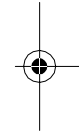

Discount-Merchant.com (800) 281-8860

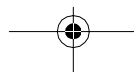

Changing the Test Pattern

1. Choose the Test Pattern Setting option from the Option menu.
The following window appears:

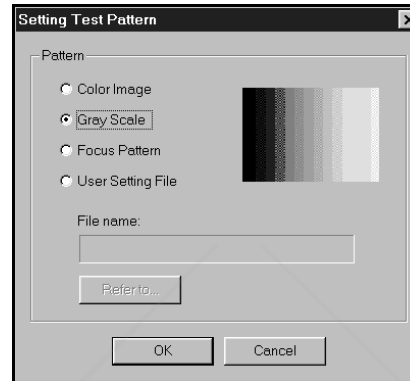

2. You can display a test pattern to verify that the projector is working properly. Choose one of the following:

Color Image	Displays a color bar test pattern.
Gray Scale	Displays a gray scale test pattern.
Focus Pattern	Displays a character-based focus pattern.
User File	Displays a bitmapped test pattern from the file name specified. Either type the name or click Refer to... to browse the hard disk for the file. The bitmap should be 1024 × 768 pixels for the PowerLite 8000i or 1366 × 1024 pixels for the PowerLite 9000i.



3. Click OK to save the settings and close the Setting Test Pattern screen.
4. Click Pattern Display on any Projector Control tab to display the selected test pattern.

Specifying an Image Gamma

1. Click the Gamma tab on the Projector Control dialog. The Gamma Setting window appears.

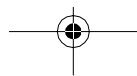
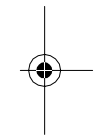
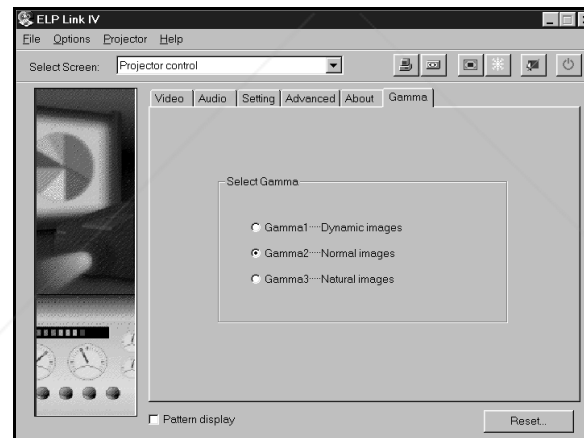

2. Select the desired gamma:
Gamma 1 Provides a dynamic and contrastive image.
Gamma 2 Provides an image between Gamma 1 and Gamma 3.
Gamma 3 Provides a natural image.
3. Click Pattern Display to display the test pattern selected.

Saving Projector Setting Files

1. Choose the Save or Save As command from the File menu. The Save As window appears.

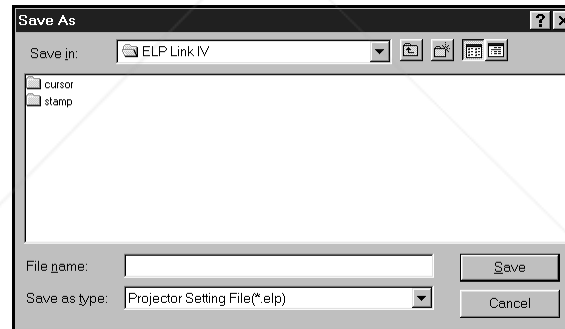

2. Enter a file name for the setting. The file will automatically be given an .elp extension.
3. Click Save.

Opening a Projector Setting File

1. Choose the Open command from the File menu. The Open window appears.

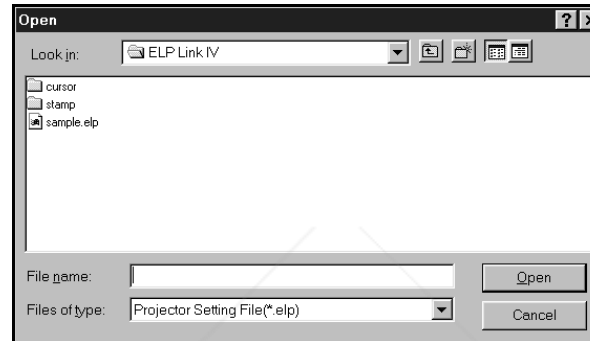

2. Locate the file (.elp) you want to open, and then click Open.

Creating a User Logo

You can create or edit a logo from the Setting User Logo dialog box, then save it to a file on your hard disk or download it to the projector.

1. Choose the Setting User logo option from the Select Screen dropdown menu. The Setting User Logo window appears.

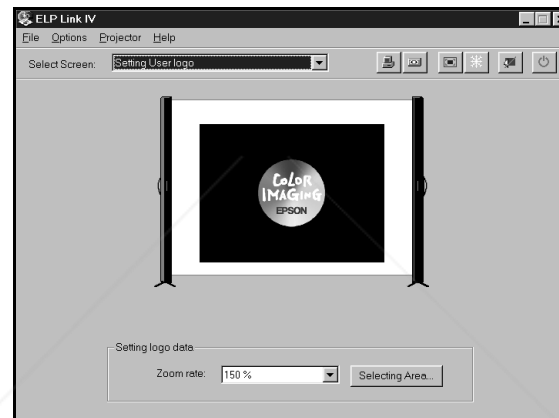

2. Choose the Open command from the File menu. The Open dialog box appears.
3. Locate and open a bitmap or logo (.bmp or .lgo) file. The selected image appears in the display area.

4. To crop the image, click the Selecting Area button. The Selecting User Logo Area window appears.

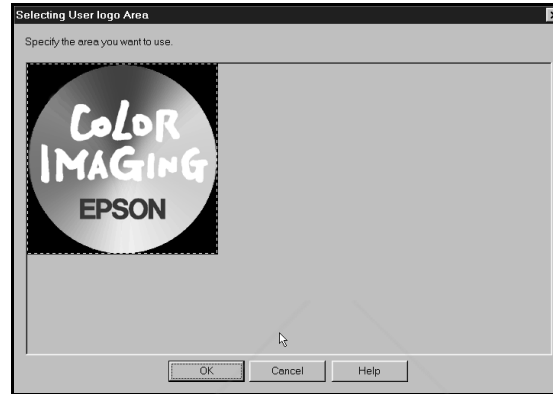

5. Drag the mouse over the area you want to use as your logo.
 6. Click OK to accept the changes. The User's Logo window reappears.
 7. To increase or decrease the size at which the logo displays, select a zoom percentage from the Zoom dropdown menu.
 8. Choose the Save command from the File menu to automatically save the logo to your hard disk. To save the logo under a different file name, choose the Save As command.
- Note: You must save logo files using the extension .lgo.*
9. To download a logo file to the projector, choose the Sending User Logo command from the Projector menu. When the confirmation message displays, click Yes.

Creating Cursors/Stamps

You can create or edit a cursor or stamp from the Cursor/Stamp Setting window.

1. Choose the Cursor/Stamp Setting option from the Select Screen dropdown menu. The Cursor/Stamp Setting window appears.

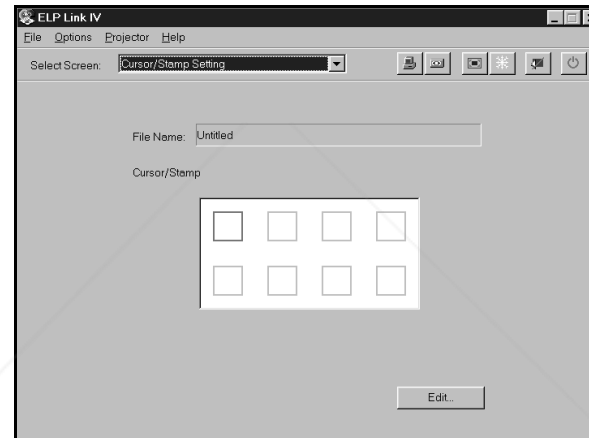



2. Click the Edit button. The Cursor/Stamp edit window appears.

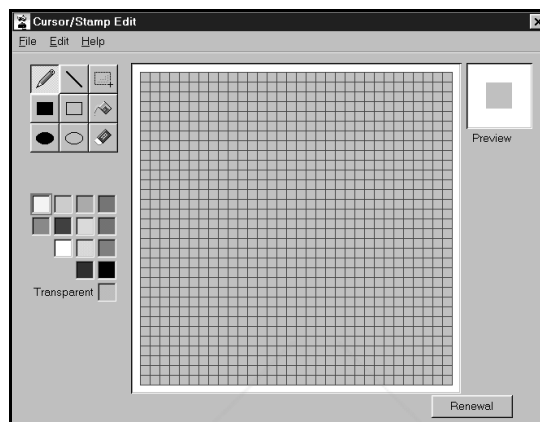

3. Create a new cursor/stamp using the pencil, line, square, ellipse, and color tools.
4. Click Renewal to insert the cursor/stamp into the next available spot in the Cursor/Stamp list.
5. Choose the Close command from the File menu to close the Edit window and redisplay the Cursor/Stamp Setting window.
6. Choose the Save or Save AS command from the File menu to save your cursor/stamps.
7. To download a cursor/stamp file to the projector, choose the Sending Cursor/Stamp command from the Projector menu. When the confirmation message is displayed, click Yes.

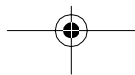



Creating a New File

To create a new set of cursors/stamps, choose the **New** command from the File menu. A blank Cursor/Stamp Setting window displays allowing you to create a new set of cursors/stamps.

Opening a File

To open a cursor/stamp file:

1. Choose the **Open** command from the File menu. A standard Windows Open dialog box appears.
2. Select the .csp file and click **Open**.
3. To edit a cursor/stamp, click on it and then click **Edit**.

Exiting the Software

To exit and close the ELP Link IV software, choose the **Exit** command from the File menu.

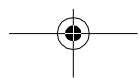

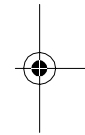
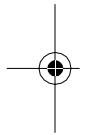
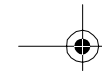

FixYourDLP.com

Sponsored by 

Discount-Merchant.com (800) 281-8860

THE TRUSTED SOURCE FOR PROJECTOR LAMPS AND ACCESSORIES

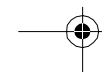
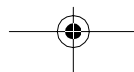

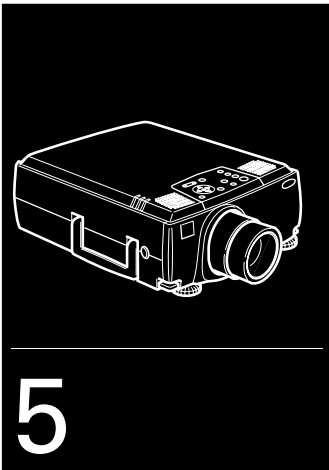

5

Maintenance

Your projector needs little maintenance. You should keep the lens clean because any dirt or smears appear on the screen. You also need to periodically clean the air filter at the bottom of the projector. A clogged air filter can block ventilation needed to cool the projector and keep it from overheating.

The only parts you should replace are the lamp and air filter. If any other part needs replacing, contact your dealer or a qualified service person.



Discount-Merchant.com (800) 281-8860

THE TRUSTED SOURCE FOR PROJECTOR LAMPS AND ACCESSORIES



Warning: Before you clean any part of the projector, turn off the projector and unplug the power cord. Never open any cover on the projector, except the lamp and filter covers. Dangerous electrical voltages in the projector can injure you severely. Do not try to service this product yourself, except as specifically explained in this User's Guide. Refer all other servicing to qualified service personnel.

Cleaning the Lens

Clean the lens whenever you notice dirt or dust on the surface. Lightly wipe the lens surface with a soft, dry, lint-free cloth. To remove dirt or smears on the lens, moisten a soft cloth with an alcohol-based cleaner and gently wipe the lens surface.

Cleaning the Projector Case

To clean the projector case, first unplug the power cord. To remove dirt or dust, wipe the case with a soft, dry, lint-free cloth. To remove stubborn dirt or stains, moisten a soft cloth with water and a neutral detergent. Then wipe the case.

Do not use alcohol, benzene, thinner, or other chemical detergents. These can cause the case to warp.

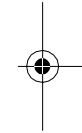
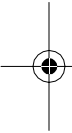

Discount-Merchant.com (800) 281-8860

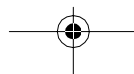

Cleaning the Air Filter

Clean the air filter at the bottom of the projector after every 100 hours of use. If it is not cleaned periodically, it can become clogged with dust, preventing proper ventilation. This can cause overheating and damage the projector. To clean the air filter, follow these steps:

1. Turn off the projector and unplug the power cable.
2. Turn the projector on its side so that the handle is on top and you can access the filter easily.

Note: Standing the projector with the handle at the top keeps dust from getting inside the projector housing.

3. Pull up on the filter cover tab to release the filter cover. Remove the cover.

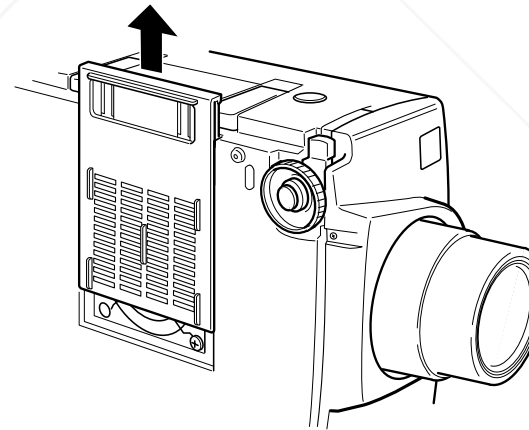



4. The filter is attached to the inside of the filter cover. It is recommended that you use a small vacuum cleaner designed for computers and other office equipment to clean the filter. If you don't have one, use a dry, lint-free cloth.

If the dirt is difficult to remove or if the filter is torn, replace it. Contact your dealer or call EPSON Accessories at (800) 873-7766 in the United States and Canada to obtain a new one.

5. Replace the filter cover when you're done.

Replacing the Lamp

The projection lamp typically lasts for about 2000 hours of use. It is time to replace the lamp when:

- The projection image gets darker or starts to deteriorate.
- The projection lamp light is either red, or flashing orange and red alternately.
- The message **LAMP REPLACE** appears on the screen when the projector lamp comes on (after about 2000 hours of use). To maintain projector brightness and image quality, replace the lamp as soon as possible.

Contact your dealer or call EPSON Accessories at (800) 873-7766 in the United States and Canada for a replacement lamp. Request part number ELPLP08.

Warning: Let the lamp cool before replacing it. Also, do not touch the glass portion of the lamp assembly. Touching the glass portion of the lamp will result in premature lamp failure.



Discount-Merchant.com (800) 281-8860

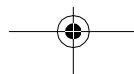
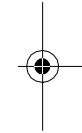
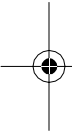

1. Turn off the projector and unplug the power cable.
2. Turn the projector over so you can access the lamp cover.
3. Use a screwdriver to loosen the two retaining screws on the lamp cover. When the screws are loose, lift off the lamp cover. (You cannot remove these screws from the cover.)

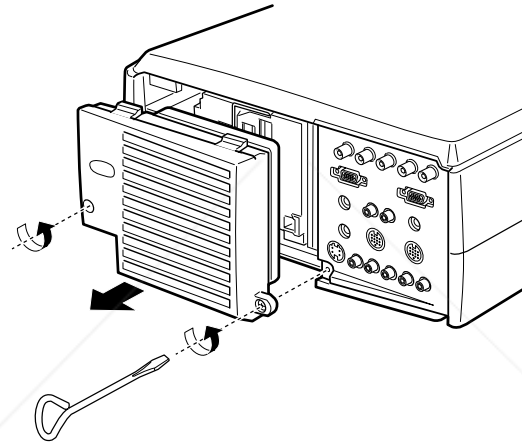

4. Use a screwdriver to loosen the three screws holding the lamp unit in place. (You cannot remove these screws.)

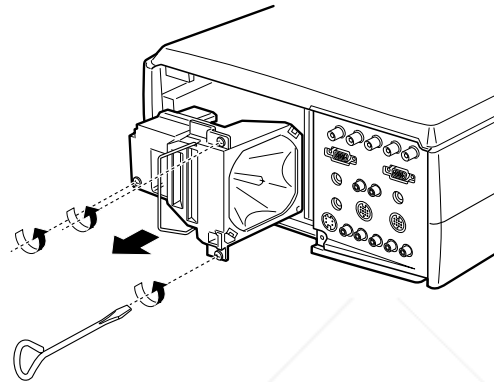

5. Lift up the handle and pull out the lamp unit.
6. Gently insert the new lamp unit by lowering it into position. Make sure it's inserted securely. Tighten the screws on the new lamp unit.
7. Replace the lamp cover and tighten the cover screws. (Make sure the lamp cover is securely fastened. The projector turns itself off if the lamp cover is open.)

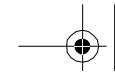

Transporting the Projector

The projector contains many glass parts and precision parts. If you need to transport it, please follow these packing guidelines to prevent damaging the projector:

- ❑ When shipping the projector for repairs, use the original packaging material if possible. If you do not have the original packaging, use equivalent materials, placing plenty of cushioning around the projector.
- ❑ When transporting the projector for business use, first put the projector in a hard-shell carrying case (such as an optional EPSON accessory case), then pack it in a firm box, using cushioning around the case.
- ❑ When you are hand-carrying the projector, be sure to store it in a carrying case (such as the optional cases offered by EPSON).

Note: EPSON shall not be liable for any damages incurred during transportation.

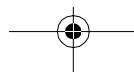
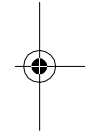
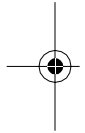

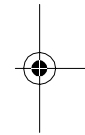
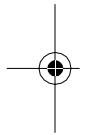

Discount-Merchant.com (800) 281-8860

THE TRUSTED SOURCE FOR PROJECTOR LAMPS AND ACCESSORIES

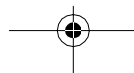

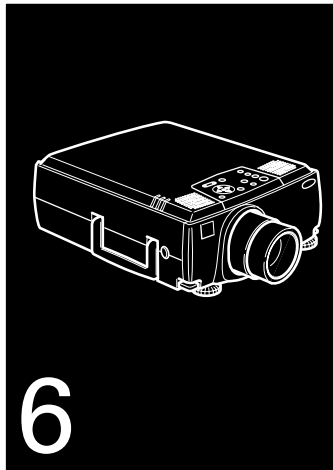

Troubleshooting

This chapter describes the problems indicated by the warning lights and provides information on how to solve problems with the projector. It is divided into the following sections:

- ❑ Problems with the projector. See this section if the projector is not working and to find out what the warning lights mean.
- ❑ Problems with the remote control. See this section if the projector is not responding to remote control commands.
- ❑ Problems with the screen image or sound. See this section if you cannot project an image or if the screen image is not good.



Discount-Merchant.com (800) 281-8860
THE TRUSTED SOURCE FOR PROJECTOR LAMPS AND ACCESSORIES

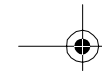

If you have a problem, check the appropriate section and follow all suggestions that apply to your problem. You can also check the online help by pressing the Help button on the control panel or remote control. If none of the suggestions solves the problem, call your dealer or contact EPSON as described on page 7.

Problems with the Projector

If you have problems with the projector, first turn it off and unplug it. Then plug the power cord back in and turn on the projector. If this does not solve the problem, check the warning lights at the top of the projector. These lights alert you to problems with projector operation.

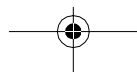
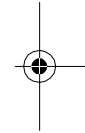
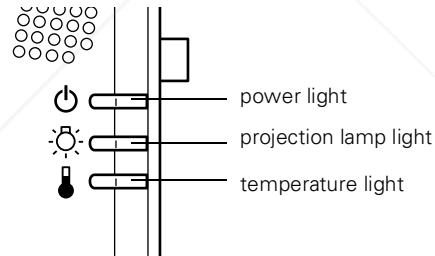
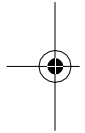

Light	Color	Meaning
Temperature	Flashing orange	The projector is hot.
	Red	The projector is too hot and has turned off automatically.
	Flashing red	There's a problem with the cooling fan or temperature sensor. Call a service representative.
Projection lamp	Red or flashing orange and red	The lamp needs to be replaced. (See "Replacing the Lamp" in Chapter 5 for instructions.)
	Flashing red	There's a problem with the projection lamp, lamp power supply, lamp fuse, or a circuit malfunction in the projector.
Power	Flashing green	The projection lamp is warming up.
	Flashing orange	The projection lamp is off and the projector is cooling down.
	Green	The projector is operating normally.
	Orange	The projector is in sleep mode.
	Red	There is a problem with the projector. Contact your service representative.
	Off	The projector has turned off automatically because of internal problems. Contact your service representative.

See the following pages for information on what to do when you see these warning lights or encounter other specific problems with the projector.



Discount-Merchant.com (800) 281-8860
THE TRUSTED SOURCE FOR PROJECTOR LAMPS AND ACCESSORIES



- ▶ **The power light is flashing orange and you cannot turn on the projector.**

The lamp is cooling down. Wait until the light turns off and then turn on the projector.

- ▶ **The power light does not come on.**

Turn off the projector, check that the power cable is connected securely both at the power outlet and the projector, and press the POWER button again. Try removing and reseating the lamp.

- ▶ **Projected images get darker or start to deteriorate, or the projection lamp light is red.**

Replace the lamp as described in Chapter 5.

- ▶ **The temperature light is red.**

The projector is overheating, which turns the lamp off automatically. Let the projector cool for a few minutes, then turn it back on. Make sure nothing is blocking the ventilation vents.

The air filter may be clogged. Clean it as described in Chapter 5 and then let the projector cool for awhile.

If the projector continues to overheat after you clean the air filter, the problem may be caused by damage to the cooling fan or internal circuits. Contact a qualified service person.

Warning: Except as specifically explained in this User's Guide, do not attempt to service this product yourself.

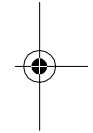
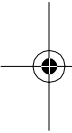

Discount-Merchant.com (800) 281-8860

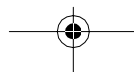



Problems with the Remote Control

- ▶ **The projector doesn't respond to remote control commands.**

Make sure the remote control is turned on. The RC switch, on the side of the remote control, should be turned to the **On** position.

The remote control unit's batteries may be low on power. Replace them.

Make sure the projector's mouse cable is securely connected to both your computer's mouse port and the projector's main cable. See Chapter 1 for details.

Make sure you selected the correct COM (communication) port for the wireless mouse control when you set up the ELP Link IV software. If necessary, you can change the COM port from the projector's Advanced menu. See page 97 for more information.

Light that is too strong, or certain types of fluorescent lighting may affect the projector's infrared receivers. Dim the ambient lighting and turn off any fluorescent lighting. Move the projector out of direct sunlight.

Turn off any nearby equipment that emits infrared energy, such as a radiant room heater.

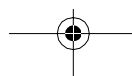
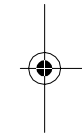



Problems with the Image or Sound

- ▶ **An image does not appear on the screen.**

Check that the power light is on and the lens cover is off. Also make sure the cables are installed correctly, as described in Chapter 1.

The correct image source may not be selected. Press the Computer button on the control panel or the Comp1, Video, or BNC button on the remote control to choose another image source.

- ▶ **Only part of the computer image is displayed.**

If the computer's output resolution setting is higher than 1024×768 for the 8000i or 1366×1024 for the 9000i, the image is resized. (See page 71 for information on resizing.)

If the computer output is not compatible with this resizing, choose a different display setting as follows.

Windows:

In Windows 95/98, right-click on the desktop, select Properties, click the Settings tab, and use the dialog box to select the resolution you want. In Windows 3.x, use Windows Setup in the Main program group.

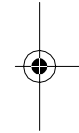
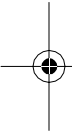

Discount-Merchant.com (800) 281-8860

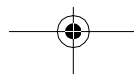

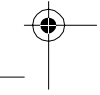

Macintosh:

For a Macintosh, choose Control Panels under the Apple menu and then choose Monitors. In the Monitors screen, choose Options and make sure Macintosh Hi-Res Display or another 1024 × 768 display for the 8000i or 1366 × 1024 display for the 9000i is selected. For supported display settings, see “Supported Monitor Displays” on page 154.

You also may need to modify existing presentation files if you created them for a different resolution. See your software manual for specific information.

- ▶ **The message NO SIGNAL is displayed.**

An image source not connected to the projector is selected, the signal is not being output from the computer, or the signal is not reaching the projector. Make sure the connectors are securely attached to both the projector and the image source. Then check that the image source is selected correctly. If your projector is attached to a Macintosh, make sure that the DIP switches on your Macintosh desktop adapter are set correctly. (See your Macintosh documentation if you need instructions.) When **NO SIGNAL** is displayed, you cannot access the Video menu.

- ▶ **A blank screen is displayed.**

The computer signal cannot be interpreted by the projector. Verify the display format (see page 154). When you see a blank screen, you cannot access the projector menus.

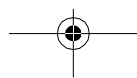
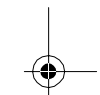
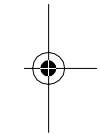



▶ **The image or parts of the image are blurred or not in focus.**

Adjust the Brightness and Contrast settings on the Video menu. If you're viewing a computer image, also try adjusting the Tracking and Sync buttons on the projector's control panel.

There may be dirt or smears on the lens. Clean the lens as described on page 136.

▶ **The image quality is poor on a laptop computer.**

The video signal may be split between the computer and the projector. If you notice a decline in the projected image quality when the image is displayed simultaneously on your laptop computer and the projector, turn off the laptop LCD display.

▶ **The colors of the image are not right.**

The color balance may be incorrect. If you're displaying a computer image, use the Color option in the Video menu to adjust the balance of red, green, and blue. If you're displaying video, adjust the Saturation and Tint (NTSC only) settings on the Video menu.

Check your monitor's color balance if you're displaying a computer image.

▶ **There is no sound.**

First check that the volume setting is not turned all the way down and that the audio cable is securely attached to both the projector and the audio source. Also, make sure the A/V Mute button is not enabled.

The wrong source is selected. Press the Computer button on the control panel to select the proper source.

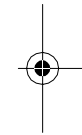
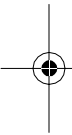

Sponsored by 

Discount-Merchant.com (800) 281-8860

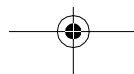



Technical Specifications

General	Type of display	Poly-silicon Thin Film Transistor (TFT)
	Size of liquid crystal panels	Diagonal: 1.3 inches (33.6 mm)
	Lens	F=1.8–2.3, f=49–69 mm
	Resolution	8000i: 1024 × 768 pixels 9000i: 1366 × 1024 pixels
	Color reproduction	24 bit, 16.7 million colors
	Brightness	8000i: 2200 lumens (ANSI) 9000i: 1700 lumens (ANSI)



Discount-Merchant.com (800) 281-8860
THE TRUSTED SOURCE FOR PROJECTOR LAMPS AND ACCESSORIES



Image size	Wide angle: 30 to 320 inches (at 3.6 to 43.3 feet distance) Tele angle: 23 to 320 inches (at 3.6 to 52.1 feet distance)
Projection distance	3.6 to 52.1 feet (1.1 to 15.9 meters)
Projection methods	Front, rear, upside-down (ceiling mount)
Internal speaker system	3 × 3 W stereo output 2 × 3 W 8 (ohm) speakers
Optical aspect ratio	4:3 (horizontal : vertical)
Zoom ratio	1:1.4
Keystone correction angle	± 20° (± 30° using ELP Link IV)
Supported video interface standards	NTSC, PAL, PAL-M, PAL-N, HDTV, SECAM
Projection Lamp	
Type	UHE (Ultra High Efficiency)
Power consumption	220 W
Lamp life	About 2000 hours
Part number	ELPLP08

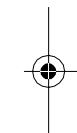

Discount-Merchant.com (800) 281-8860

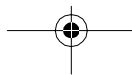



Remote Control

Range	32.8 feet (10 meters)
Batteries	Alkaline AA (2)

Mouse Compatibility

Supports PS/2, USB, serial, ADB

Remote IR Receiver

Supports EPSON Remote IR Receiver, 10-foot cable (typical use for rear screen projection)

Mechanical

Height	6.1 inches (157 mm)
Width	12 inches (305 mm)
Depth	19.8 inches (475 mm)
Weight	18.3 lb (8.3 kg)

Electrical

Rated frequency	50/60 Hz
Power supply	100 to 120 VAC, 2.4 A 200 to 240 VAC, 1.2 A
Power consumption	Operating: 360 W Standby: 12 W

Environmental Temperature

Operating: 41 to 104° F (5 to 40° C), non-condensing

Storage: 14 to 140° F (-10 to 60° C), non-condensing

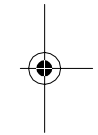

Discount-Merchant.com (800) 281-8860
THE TRUSTED SOURCE FOR PROJECTOR LAMPS AND ACCESSORIES

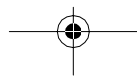



Humidity Operating: 20 to 80% RH,
 non-condensing

 Storage: 10 to 90% RH,
 non-condensing

Safety United States FCC Part 15J Class B
 UL1950 Rev. 3

 Canada DOC SOR/88-475
 CSA C22.2 No. 950 Rev. 3

CE Marking Directive 89/336/EEC
 EN 55022 Class B
 EN 50082-1

 Directive 73/23/EEC
 EN 60950

Supported Monitor Displays

The following table lists the display formats supported by the projector:

Mode	Resolution	Frequency H(KHz)/V(Hz)	Dot (MHz)
VGACGA	640 x 400	31.46 / 70	25.175
VGAEGA	640 x 350	31.46 / 70	25.175
NEC400	640 x 400	24.83 / 56.65	21.053



Discount-Merchant.com (800) 281-8860

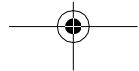

Mode	Resolution	Frequency H(KHz)/V(Hz)	Dot (MHz)
VGA60	640 x 480	31.469 / 59.94	25.175
VGA72	640 x 480	37.861 / 72.809	31.5
VGA75	640 x 480	37.5 / 75	31.5
VGA85	640 x 480	48.269 / 85.008	36
SVGA56	800 x 600	35.156 / 56.25	36
SVGA60	800 x 600	37.879 / 60.317	40
SVGA72	800 x 600	48.077 / 72.188	50
SVGA75	800 x 600	46.875 / 75	49.5
SVGA85	800 x 600	53.674 / 85.061	56.25
XGA43i	1024 x 768	35.522 / 86.958	44.9
XGA60	1024 x 768	48.363 / 60.004	65
XGA70	1024 x 768	56.476 / 70.069	75
XGA75	1024 x 768	60.023 / 75.029	78.75
XGA85	1024 x 768	68.677 / 84.997	94.5
SXGA1_70	1152 x 864	63.851 / 70.012	94.5
SXGA1_75	1152 x 864	67.5 / 75	108
SXGA1_85	1152 x 864	77.094 / 84.002	121.5
SXGA2_60	1280 x 960	60 / 60	108
SXGA2_75	1280 x 960	75 / 75	126
SXGA2_85	1280 x 960	85.938 / 85.002	148.5
SXGA3_43i	1280 x 1024	46.433 / 86.871	78.75
SXGA3_60	1280 x 1024	63.981 / 60.02	108
SXGA3_75	1280 x 1024	79.976 / 75.025	135
SXGA_85	1280 x 1024	91.146 / 85.024	157.5

Mode	Resolution	Frequency H(KHz)/V(Hz)	Dot (MHz)
UXGA48i	1600 x 1200	62.5 / 96.080	135
UXGA60	1600 x 1200	75 / 60	162
UXGA65	1600 x 1200	81.25 / 65	175.5
UXGA70	1600 x 1200	87.5 / 70	189
UXGA75	1600 x 1200	93.75 / 75	202.5
MACLC13	640 x 480	34.975 / 66.62	31.33
MACII13	640 x 480	35 / 66.67	30.24
MAC16	832 x 624	49.725 / 74.55	57.28
MAC19-60	1024 x 768	48.193 / 59.28	64
MAC19	1024 x 768	60.241 / 74.93	80
MAC21	1152 x 870	68.682 / 75.062	100
HDTV480P (ANSI/SMPTE)	720 x 483	31.469 / 59.940	27
HDTV480P (ATSC)	704 x 480	31.469 / 59.940	27
HDTV480I (ANSI/SMPTE)	720 x 487	15.734 / 59.940	13.5
HDTV480I (ATSC)	704 x 480	15.734 / 59.940	13.5
HDTV720P (SMPTE)	1280 x 720	44.955 / 59.940	74.176
HDTV1080I (ANSI/SMPTE)	1920 x 1080	67.433 / 59.940	148.352
HDTV1080I (ANSI/SMPTE)	1920 x 1080	33.716 / 59.940	74.176



Discount-Merchant.com (800) 281-8860

Mode	Resolution	Frequency H(KHz)/V(Hz)	Dot (MHz)
NTSC (SXGA)	1366 x 438	15.734 / 60	28.486
NTSC (XGA)	1024 x 438	15.734 / 60	2.890
PAL (SXGA)	1366 x 512	15.625 / 50	28.846
PAL (XGA)	1024 x 512	15.625 / 50	21.154
SECAM (SXGA)	1366 x 512	15.625 / 50	28.846
SECAM (XGA)	1024 x 512	15.625 / 50	21.154

Note: The frequencies of some computers may not allow the image to be displayed correctly.



Discount-Merchant.com (800) 281-8860
THE TRUSTED SOURCE FOR PROJECTOR LAMPS AND ACCESSORIES

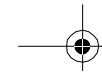

Computer 1 and 2 and Computer Out connector pin assignments

The Computer 1, 2, and Computer Out connectors are female video RGB, 15-pin micro-D-style connectors. Here are the pin assignments:

Input pin	Computer Out connector signals	Computer 1 and 2 connector signals
1	Red out / red video	Red video
2	Green out / green video	Green video
3	Blue out / blue video	Blue video
4	Reserved	Monitor (ID bit 2)
5	GND	GND
6	GND	Red video GND
7	GND	Green video GND
8	GND	Blue video GND
9	Reserved	+5 V
10	GND	Synchronous GND
11	Reserved	Monitor (ID bit 0)
12	Reserved	SDA
13	Horizontal sync	Horizontal sync
14	Vertical sync	Vertical sync
15	Vertical sync	Reserved

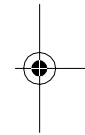
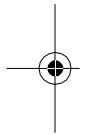

Discount-Merchant.com (800) 281-8860

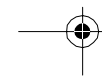
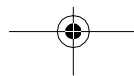

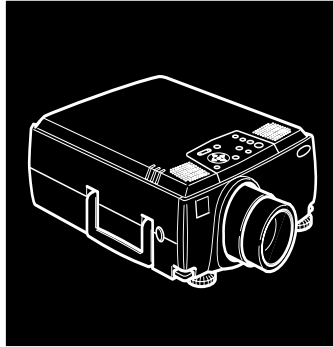

Glossary

Brightness. The balance of light and dark shades in an image.

Component video. The recording and transmission of video using separate red, green, blue and synchronization signals.

Composite video. A type of video signal that encodes picture, luminance, and synchronization information so it can be carried in one signal.

Contrast. A measure of the tonal differences between the highlights and shadows of an image. In a high-contrast image, light areas are very bright and dark areas are very dark, with relatively few levels of gray between white and black. Contrast is decreased by adding grays.

DPMS. Display Power Management Signaling. A power saving feature that powers down a computer's monitor when it has been idle for a specified amount of time.



Discount-Merchant.com (800) 281-8860
THE TRUSTED SOURCE FOR PROJECTOR LAMPS AND ACCESSORIES



NTSC. A 525-line video broadcast format developed by the National Television Standards Committee. NTSC is widely used in North America, Mexico, and Japan.

PAL (Phase Alternation by Line). A 625-line video broadcast format used in Western Europe, India, China, Australia, New Zealand, and parts of Africa.

Point. A measurement of drawn or printed objects. One point equals 1/72 inch.

Resolution. A measure of the amount of detail contained in an image. Resolution can be measured in dots per inch or in pixels. Image sharpness and clarity improve as resolution increases.

RGB. A type of color scheme that defines color as percentages of red, green, and blue.

S-Video. A type of video signal used in S-VHS videotape formats. It transmits luminance and color separately.

SECAM (System Electronique pour Couleur Avec Memoire). A 625-line TV system used in France, Eastern Europe, Russia, and parts of Africa.

Sleep mode. A power-saving feature in which the projection lamp is turned off when a video signal has not been applied for 30 minutes. In sleep mode, only a minimum amount of the projector's circuitry remains on.

SVGA. Super Video Graphics Array. SVGA provides higher resolution than VGA (800 × 600).

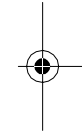
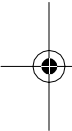

FixYourDLP.com

Sponsored by 

Discount-Merchant.com (800) 281-8860

160

Glossary

THE TRUSTED SOURCE FOR PROJECTOR LAMPS AND ACCESSORIES

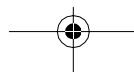



SXGA. Super Extended Graphics Array. SXGA provides higher resolution than XGA (1280 × 1024).

UXGA. Ultra Extended Graphics Array. UXGA provides higher resolution than SXGA (1600 × 1200).

VGA. Video Graphics Array. A high-resolution display adapter that provides a variety of video modes (640 × 480).

XGA. Extended Graphics Array. IBM's display adapter, XGA provides higher resolution than VGA (1024 × 768).

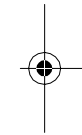

Discount-Merchant.com (800) 281-8860
THE TRUSTED SOURCE FOR PROJECTOR LAMPS AND ACCESSORIES



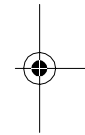
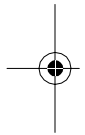
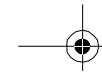

FixYourDLP.com

Sponsored by DM

Discount-Merchant.com (800) 281-8860

THE TRUSTED SOURCE FOR PROJECTOR LAMPS AND ACCESSORIES

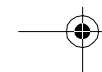
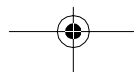

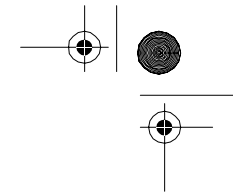
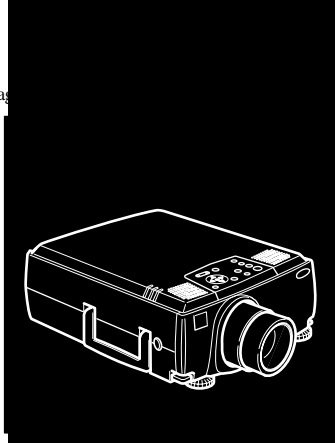
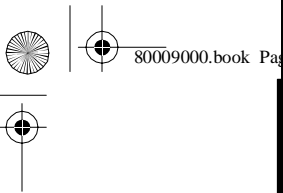

Index

Numerics

3D Sound, 92, 121

A

A/V Mute Button, 96

About menu, 84, 99

Accessories, 4 to 5, 9

Advanced menu, 84

Air filter, cleaning, 137 to 138

Amplification, 56 to 57

Anti-theft device, 17

Audio

connecting desktop, 28, 42

connecting laptop, 33

connecting PowerBook, 51

menu, 83, 92

B

Bar function, 114

Bass, 92, 121

Batteries, installing, 18 to 19

BNC Format, 94, 122

Brightness, 89, 91, 119, 120, 151, 159

Buttons

control panel, 78 to 80, 86 to 87

customizing the Effects buttons, 107 to 116

remote control, 73 to 77, 86 to 87

C

Cables, 4, 14 to 17

Camcorder, adjusting the projected image, 90 to 91, 99

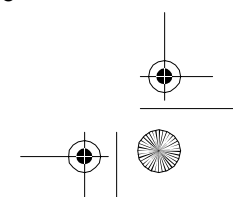
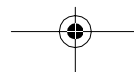
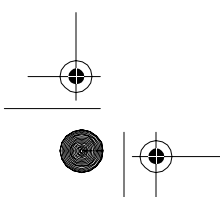



- Case, cleaning, 136
 - CE Marking, 154
 - Ceiling, hanging the projector from, 98, 99, 123
 - Cleaning
 - air filter, 137 to 138
 - lens, 136
 - projector case, 136
 - Color
 - balance, 91, 119, 120
 - menu option, 89
 - saturation, 91, 119, 120
 - COM port, changing, 106
 - CompuServe, 7
 - Computer connector pin assignments, 158
 - Computer, adjusting projected image for, 88 to 91
 - Connecting projector
 - to a desktop Macintosh, 34 to 42
 - to a desktop PC, 22 to 28
 - to a high-end workstation, 52
 - to a laptop PC, 29 to 33
 - to a PA system, 56 to 57
 - to a PowerBook, 43 to 51
 - to a video source, 52 to 55
 - to an external speaker, 56 to 57
 - Connector pin assignments, 158
 - Contrast, 89, 91, 119, 120, 159
 - Control panel
 - buttons, 78 to 80
 - functions, 78 to 80
 - using, 78 to 80
 - Cursor
 - changing shape, 109, 114
 - creating, 131 to 133
 - Customizing the Effects buttons, 107 to 115
- D**
- DIP switches, 36, 45
 - Display formats, supported, 154 to 157
 - Distance from projector to screen, 19 to 20, 62 to 68
 - Drawing screen graphics, 108 to 110, 113
- E**
- Effect menu, 83, 93
 - Effects buttons
 - assigning functions, 111
 - customizing, 107 to 115
 - function options, 113 to 115
 - functions list, 107 to 110
 - saving and recalling assignments, 116
 - Electrical specifications, 153
 - Ellipse, 108, 113

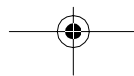



ELP Link IV, 101

About tab, 123 to 124

Advanced tab, 123

Audio tab, 121

Gamma tab, 124

installing, 102 to 104

launching, 105 to 106

Setting tab, 122

using, 105 to 133

Video tab, 119 to 120

Environmental specifications, 153 to 154

EPSON support, 7 to 8

External speakers, 56 to 57

F

FaxAdvice, EPSON, 8

Features, 1 to 2

Feet, raising or lowering, 70

Fixed short throw lens, 68

Focusing, 69 to 70

Formats, supported display, 154 to 157

Freeze button, 76

FTP site, EPSON, 7

G

Graphics, drawing screen, 108 to 110, 113 to 114

H

Help, EPSON, 7 to 9

High-end workstation, 52

Humidity requirements, 154

I

Image

adjusting position, 69 to 71, 88, 90, 119

adjusting quality, 88 to 91

leaving a copy on the screen, 109

problems, 148 to 150

resizing, 71

size range, 152

Image Gamma, 126 to 127

Infrared receivers, location, 62

Installing batteries, 18 to 19

Installing the ELP Link IV software, 102 to 104

Internet, 7

K

Key Macro function, 110, 115

Keystone, 64, 71

L

Lamp

light, 80 to 81, 144 to 145

replacing, 138 to 140

specifications, 152

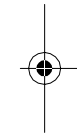

FixYourDLP.com

Sponsored by

Discount-Merchant.com (800) 281-8860 165

THE TRUSTED SOURCE FOR PROJECTOR LAMPS AND ACCESSORIES





Language menu option, 97
Laptop, connecting to, 29 to 33, 43 to 51
Launching the ELP Link IV software, 105 to 106

Lens

accessories, 4
cleaning, 136
fixed short throw, 4, 68
long throw zoom, 4, 66 to 67
short throw zoom, 4, 67
standard, 65 to 66

Lights, status, 80 to 82, 144 to 146

Line function, 108, 113

Logo, creating, 129 to 130

Long throw zoom lens, 66 to 68

Lumens, 151

M

Macintosh

connecting projector to, 34 to 51
installing software, 104

Mechanical specifications, 153

Menus

accessing, 85
Audio, 83, 92
changing settings, 86 to 88
Video, 83, 88 to 91

Monitors, supported, 154 to 157

O

Online Help, 3

Options for the projector, 4 to 5

P

PA system, 56 to 57

Pin assignments, connector, 158

Pointer button, 76

Positioning the projector, 19 to 20, 62 to 68

Positioning the screen image, 69 to 70, 88, 90, 119

Power

button, 76 to 78
consumption, 153
light, 80 to 81, 144 to 146
supply, 153

PowerBook, connecting projector to, 43 to 51

Projection lamp light, 80 to 81, 144 to 145

Projector

connecting, 21 to 57
distance to screen, 20, 63 to 68
focusing, 69 to 70
hanging from the ceiling, 98, 99, 123
lamp specifications, 152
parts identified, 62
positioning, 19 to 20, 62 to 68
positioning the screen image, 69 to 70, 88, 90, 119

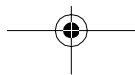



Projector (continued)
 problems, 144 to 146
 setting up, 13 to 57
 status lights, 80 to 82, 144 to 146
 turning on and off, 57 to 58
 unpacking, 14 to 16
 using the Quick Change Toolbar, 117
 Projector case, cleaning, 136
 Projector Setting window, 117 to 124
 Prompt menu option, 94

Q

Quick Change Toolbar, 117

R

RCA video cable, 54
 Rear projection, 98, 123
 Remote control
 buttons, 73 to 77, 86 to 87
 customizing the Effects buttons, 107 to 116
 functions, 76 to 77
 problems, 147
 specifications, 153
 using, 3, 73 to 77
 Remote control effects, 75
 Remote control features, 76
 Replacing the lamp, 138 to 140
 Reset All menu, 84, 97

Resize button, 71
 Resolution, 151, 160

S

Safety instructions, 9 to 11
 Screen image, problems, 148 to 150
 Setting menu, 84, 94
 Short throw zoom lens, 67
 Sleep mode, 3, 72, 160
 Software
 installing, 102 to 104
 launching, 105 to 106
 using, 105 to 133
 Sound problems, 150
 Speakers
 adjusting the tone, 92, 121
 adjusting the volume, 92, 121
 connecting projector to, 56 to 57
 Specifications
 electrical, 153
 environmental, 153 to 154
 general, 151 to 152
 lamp, 152
 mechanical, 153
 remote control, 153
 safety, 154
 SRS CENTER, 92, 121
 SRS SPACE, 92, 121
 Stamp function, 109, 114



FixYourDLP.com

Sponsored by 

Discount-Merchant.com (800) 281-8860 167

THE TRUSTED SOURCE FOR PROJECTOR LAMPS AND ACCESSORIES

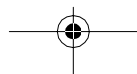



Stamp, creating, 131 to 133
Status lights, 80 to 82, 144 to 146
Support, technical, 7 to 9
S-Video signal, 17, 160
Sync, 88, 119, 120

T

Temperature
 light, 82, 144 to 146
 requirements, 153
Test pattern
 changing, 125 to 126
 displaying, 119, 120

Tint, 91

Tone, adjusting, 92, 121

Toolbar, using, 117

Tracking, 88, 119, 120

Treble, 92, 121

Troubleshooting
 image and sound problems, 148 to 150
 projector problems, 144 to 146
 remote control problems, 147
Turning the projector on and off, 57 to 58

U

Unpacking projector, 14 to 16

User logo, creating, 129 to 130

User's Logo menu, 84, 95

UXGA, 2, 161

V

VCR, adjusting the projected image, 90 to 91, 99

VGA, 2, 161

Video

 adjusting projected image for, 90 to 91
 jacks, 54
 menus, 83, 88 to 91

Video source, connecting projector to, 52 to 55

Volume, 92, 121

W

Warning lights, 80 to 82, 144 to 146

Workstations, connecting projector to, 52

World Wide Web, 7

X

XGA, 2, 161

Z

Zoom ratio, 152

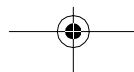
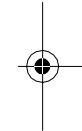
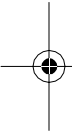



Disclaimer

This user manual is provided as a free service by FixYourDLP.com. FixYourDLP is in no way responsible for the content of this manual, nor do we guarantee its accuracy. FixYourDLP does not make any claim of copyright and all copyrights remain the property of their respective owners.

About FixYourDLP.com

FixYourDLP.com (<http://www.fixyourdpl.com>) is the World's #1 resource for media product news, reviews, do-it-yourself guides, and manuals.

Informational Blog: <http://www.fixyourdpl.com>

Video Guides: <http://www.fixyourdpl.com/guides>

User Forums: <http://www.fixyourdpl.com/forum>

FixYourDLP's Fight Against Counterfeit Lamps:

<http://www.fixyourdpl.com/counterfeits>

Sponsors:

RecycleYourLamp.org – Free lamp recycling services for used lamps:

<http://www.recycleyourlamp.org>

Lamp Research - The trusted 3rd party lamp research company:

<http://www.lampresearch.com>

Discount-Merchant.com – The worlds largest lamp distributor:

<http://www.discount-merchant.com>



FixYourDLP.com

Sponsored by 